

# VISTA DIRECT SET™ INSTALL GUIDE

## MANUFACTURING

2200 Murphy Court  
North Port, Florida 34289  
888.989.3876 • 941.979.5316

888.989.EURO (3876)  
[www.euro-wall.com](http://www.euro-wall.com)

## SHOWROOM

1211 Stirling Road, Unit 102,  
Dania Beach, Florida 33004

## Important

Before beginning the install, read the instructions in their entirety. Perform install using the recommended methods contained within this guide. Deviating from recommended install procedures could impair functionality and could void any warranty.

## Caution

It is the obligation of the building owner, contractor, architect or installer to ensure that door systems being installed comply with all building codes and regulations pertaining to the install location. Euro-Wall Systems, Inc. assumes no responsibility for failure to meet applicable laws, ordinances, building codes, etc.

## Description of Supplied Parts

Upon delivery please inspect for any noticeable damage and check supplied materials with included packing list. If there is any damage and / or any missing components, please contact Euro-Wall as soon as possible. For installs with multiple opening units, do not mix and match any components even if the units are the same dimensions.

## Protection of Unit During Construction

It is important that during the construction phase the door system components are protected and covered in a clean dry location away from any factors that could cause damage. Door systems that are stored during the construction phase can often times be exposed to situations that can cause permanent damage such as cement splatter, tar, paint, weld spray, falling objects, construction dust, sandblasting, etc. After installation of the door system is completed and construction is still being performed, ensure that the large opening where the door system is installed does not become a major in and out access point for contractors and subcontractors. Damage done during the construction phase can be irreparable and can cause significant setbacks with new panels needing to be constructed.

## Panel Protective Film

If your project comes with protective film, remove all protective film from panels, frames and any other metal extrusion within 30 days of job delivery. Failure to do so could cause finish damage voiding the product warranty.

## Considerations Before You Get Started

**Space:** Make sure you have the appropriate working space in and around the install opening. It is best practice to assemble the frame on top of saw horses (using at least four, one for each corner), therefore, make sure you have adequate room to assemble the frame in the area around the opening. Additionally, leave plenty of room without clutter to maneuver panels during install.

**Power:** Ideally power should be connected and accessible for tool operation and to ensure optimal lighting conditions for the install.

**Moving Panels:** Never “walk panels” and never try to move panels with only one person. Always lift and move panels by hand or using glass suction cups using at least two people. For installs less than 8’ in height, use a minimum of two installers. For panels over 8’ tall, a team of four is recommend for the install.

## A. Tools Required

### Step A.1 - Tools Checklist

Please make sure you have all of the required tools listed below before performing the install.

- ✓ Screw guns/chargers
- ✓ Drill bits for steel, concrete, wood
- ✓ Drill bits for selected substrate screws
- ✓ Rubber mallet
- ✓ Glazing block
- ✓ SDS Drill
- ✓ Levels
- ✓ Pencil
- ✓ Snips
- ✓ Utility knife
- ✓ Saw horses
- ✓ Glass cups for moving glass/panel
- ✓ Shop vac
- ✓ Broom/Dustpan
- ✓ Garbage can/bags
- ✓ Copy of install guide

### Step A.2 - Disposables Checklist

Please make sure you have all of the required tools listed below before performing the install.

- ✓ Tapcons (concrete)
- ✓ Frame install screws
- ✓ Caulk/sealant
- ✓ Lubricant
- ✓ Shims
- ✓ Glass cleaner
- ✓ Rags/towels
- ✓ Cardboard/moving blankets

### Step A.3 - Labor Checklist

Please make sure you have the adequate number of installers

- ✓ For installations with panels under 8 feet, recommended minimum of 2 installers
- ✓ For installations with panels over 8 feet, recommended minimum of 4 installers

## B. Parts / Pieces Included

Below you will find a summary of the parts and pieces that are included with the door system. For a comprehensive checklist please see the packing list included with your order.

### Step B.1 - Frame Checklist

- ✓ *Frame pieces (4) (setting blocks pre-installed)*
- ✓ *Frame gasket (4)*
- ✓ *Frame L brackets (8)*
- If multi:*
- ✓ *Female dividers (# of sections - 1)*
- ✓ *Female divider covers (loose; installed after assembly)*
- ✓ *Male dividers (# of sections - 1; covers pre-installed)*
- ✓ *Wedge gasket*
- ✓ *Bed gasket (frame and/or dividers) (might be pre-installed here, but not sure yet)*
- ✓ *Frame screws*
- ✓ *Divider bolts*

### Step B.2 - Glass Checklist (Multi only)

Each system comes with a number of panels allocated in the work order. Each door panel must be installed in the correct sequence, please refer to the installation drawing and panel labeling for the correct install sequence.

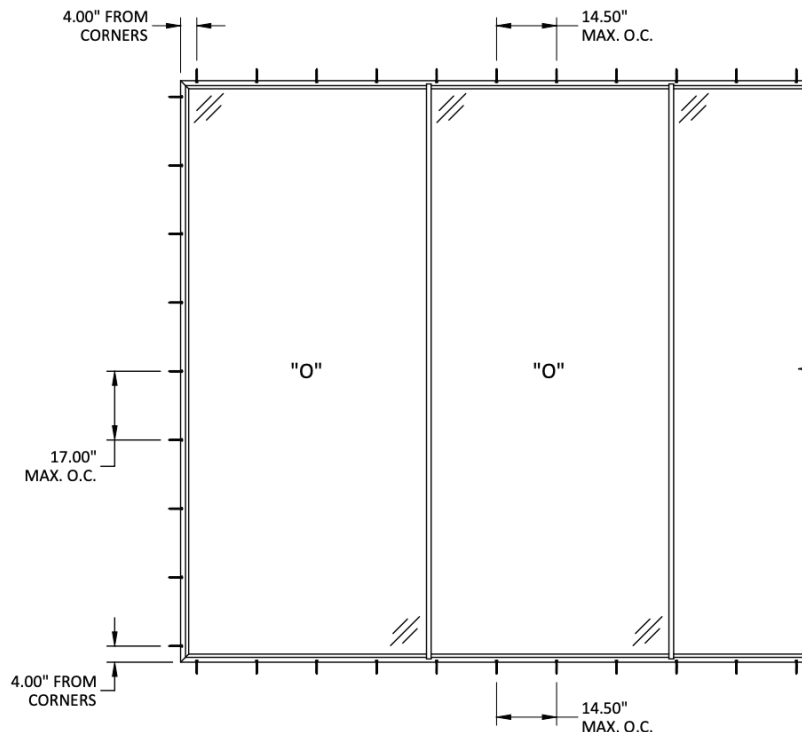

**FIGURE B.2: PARTS CHECKLIST**

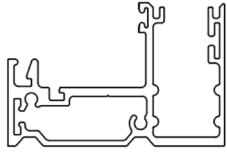

E0223-A\_SF2\_Frm  
**Frame pieces**

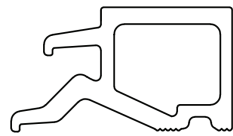

E0225-B  
**9/16" Reducer  
(9/16" Glass)**

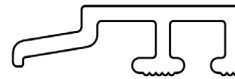

E0010-A  
**1" Glazing Bead  
(1" Glass)**

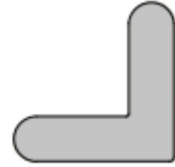

C0194-A-SF\_Cmr\_Key  
**Frame L-brackets**



E0228-A\_SF2\_DF  
**Female Dividers**

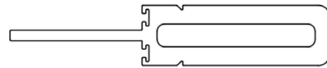

E0227-A\_SF2\_DM  
**Male Dividers**

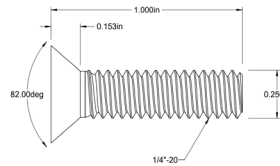

**Divider Screws**



**Frame Screws**



C0019-A\_Bed\_Gskt  
**Bedding Gasket  
(Frame)**



C0055-A\_Bed\_Gskt  
**Bedding Gasket  
(Divider)**



C0020-A\_Wdg\_Gskt  
**Wedge Gasket**

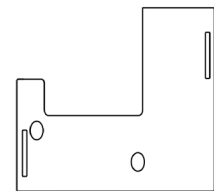

C0320-\_SF2-Gskt  
**Frame Gasket**



E0230-A\_SF2\_DCvr\_Female  
**Female Divider Cover**



E0224-A\_SF2\_FrmCvr  
**Frame Cover**

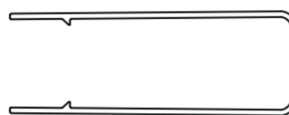

E0229-A\_SF2\_DCvr\_Male  
**Male Divider Cover**

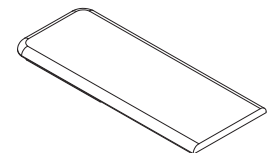

C0286-B  
**Divider Cap**

## C. Opening Preparation

### Step C.1 - Measure, Level, Square & Clean

- ✓ Measure opening at least 3 points (see **Figure C.1**) to check for plumb, square and level of the opening
- ✓ Ensure that there is only a maximum header deflection of 3/16" or less
- ✓ Vacuum / sweep opening to be clear of dust / dirt / debris

**FIGURE C.1: MEASURING THE OPENING**

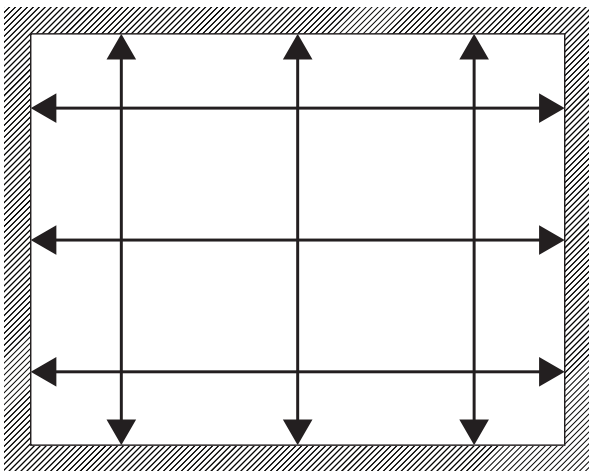

ANCHOR SCHEDULE			
SUBSTRATE	ANCHOR TYPE	MIN. EMBEDMENT	MIN. EDGE DISTANCE
WOOD: MIN. SG = 0.55	5/16" DEWALT ULTRACON	1-1/2"	1-9/16"
METAL: STEEL 18 GAUGE, MIN. F <sub>y</sub> = 33KSI	5/16" SELF-DRILLING OR SELF-TAPPING SCREW	3 THREADS MIN PENETRATION BEYOND METAL	1/2"
METAL: ALUMINUM (6063-T5) MIN 1/8" THICKNESS	5/16" SELF-DRILLING OR SELF-TAPPING SCREW	3 THREADS MIN PENETRATION BEYOND METAL	1/2"
CONCRETE: f' <sub>c</sub> = 3000PSI	5/16" DEWALT ULTRACON	1-3/4"	2-1/2"
MASONRY: GROUT FILLED CMU PER ASTM C90	5/16" DEWALT ULTRACON	1-3/4"	2-1/2"

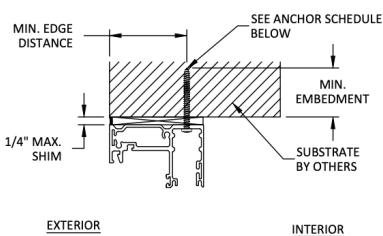

**A** ANCHOR DETAIL HEAD

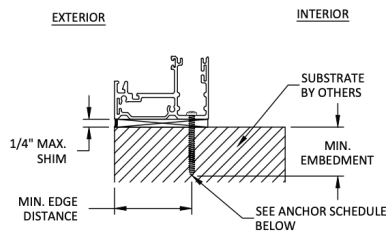

**B** ANCHOR DETAIL SILL

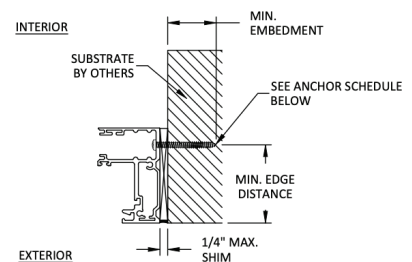

**C** ANCHOR DETAIL JAMB

## D. Prepare the Frame

### Step D.1 - Apply the Frame Gasket

Apply the provided frame gasket to the angled corners of the frame.

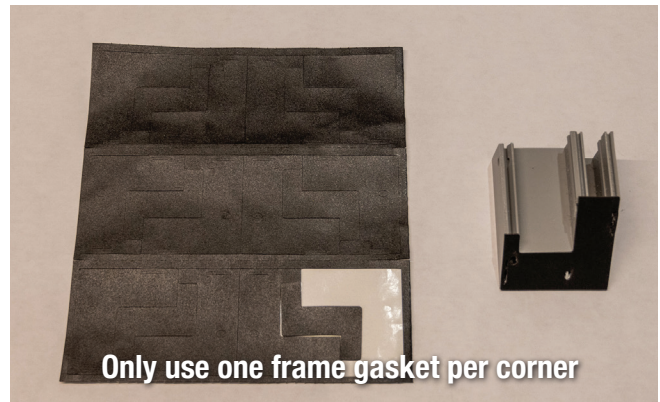

---

### Step D.2 - Insert L-Brackets

Install the L-brackets into the angled corners of the frame. Ensure they're pushed all the way in.



---

## E. Assemble Frame

### Step E.1 - Join the Frame

Join the frame using the L-brackets for alignment.



**NOTE:** Use 2 L-brackets per corner.

### Step E.2 - Screws

Fasten the frame using the provided frame screws. Ensure good alignment of frame pieces prior to installing frame screws. Failure to align the frame could result in damage to the frame.

Cover screws with silicone to ensure watertight seal.



---

### Step E.3 - Install Bedding Gasket

Insert frame bedding gasket into frame.

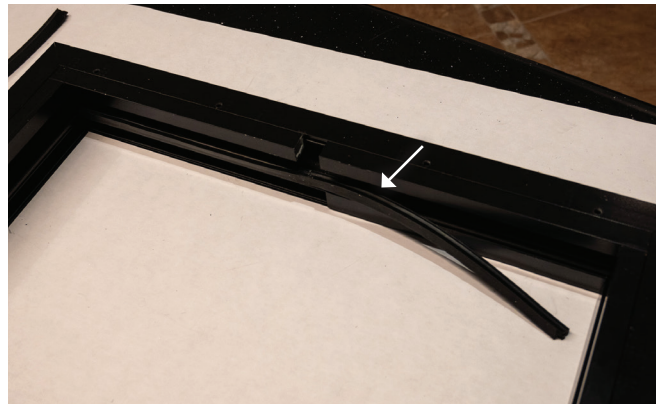

---

## F. Dry Fit Frame

### Step F.1 - Fit and Tack Frame into Place

Make sure opening is clean and clear of dirt / debris. Move frame into opening verifying opening is large enough. With the frame in position, temporarily tack into place through the jambs. All anchor screw locations on the frame come pre-drilled.

**QR CODE: DRY FIT  
FRAME PROCESS**





## Step F.2 - Level & Plumb Frame

Check sill for level and plumb, shim where necessary. There should be no more than 1/16” sill sag at the center span of the sill. There should be no bow in the sill at any location.



---

## Step F.3 - Pre-Drill Opening Substrate

Once the frame is shimmed and leveled, prepare the substrate by drilling through all frame anchor screw locations into the opening substrate where necessary. The type of drill bit used will vary depending on the substrate. Remove frame and vacuum / sweep clean debris.



---

# G. Install the Frame

## Step G.1 - Sealing Sill Track Opening

Make sure opening is clean of all dirt and debris. Seal sill opening location with DOW 795 or 100% silicone. Place frame into opening and embed entire sill into the sealant.



QR CODE:  
SEALING THE SILL OPENING



**NOTE:** All frame anchor screw locations are pre-drilled

### Step G.2 - Securing the Sill

Position frame so that the jamb is plumb and level with adequate space for shimming and then tack into place with screws. Repeat for the second jamb. Proceed to securing the sill. Level the sill placing shims at least at every other pre-drilled anchor screw location and anywhere else shimming is needed. **Make sure to use hex head anchor screws only when securing the sill.** Dip screws in silicone and secure sill at every anchor screw location. Ensure that the sill remains level after every anchor location is secured and adjust as necessary.



Dip all sill track screws in silicone

QR CODE: SECURING THE SILL



### Step G.3 - Securing the Jambs

Re-check jambs for level and plumb and secure jamb into place with screws. Do not over tighten screws as this could cause the frame to bow. After screwing the jambs securely into the opening, check again for level and plumb.



### Step G.4 - Securing the Header

Starting at either of the jambs, shim and secure the header into place proceeding down the entire length of the header checking for level with a two foot level. Take care not to over tighten screws. After header is secured, re-verify level with a four foot level across the entire length of the header.



## H. Install Glass

### Step H.1 - Install Glass

Starting from one side of the unit, place the first section of glass in the frame from the exterior side.

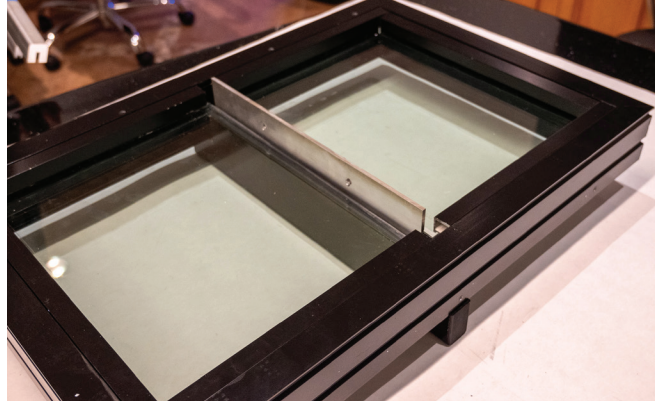

---

### Step H.2 - Install Reducer or Glazing Bead

Snap in either the reducer or the glazing bead (depending on glass type) on the top and bottom. Repeat the previous for each glass section. Once all glass is in place, snap in the two vertical pieces of reducer/bead.



---

## I. Install Divider(s)

### Step I.1 - Install Bedding Gasket on Dividers

Install the divider bedding gasket onto the interior divider.

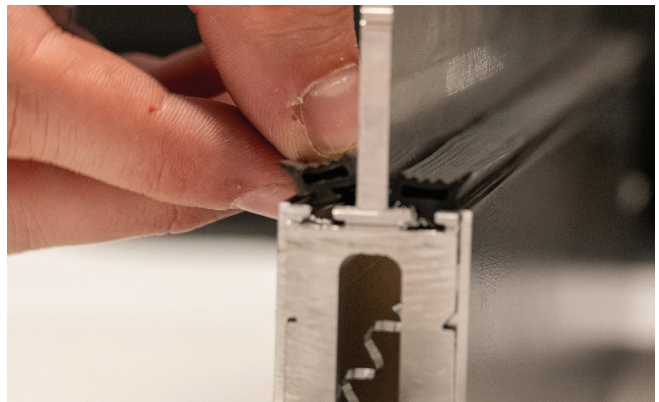

### Step I.2 - Install Male Divider

Insert male divider by placing it between the glass sections.

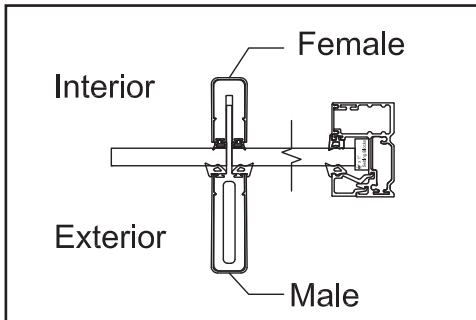
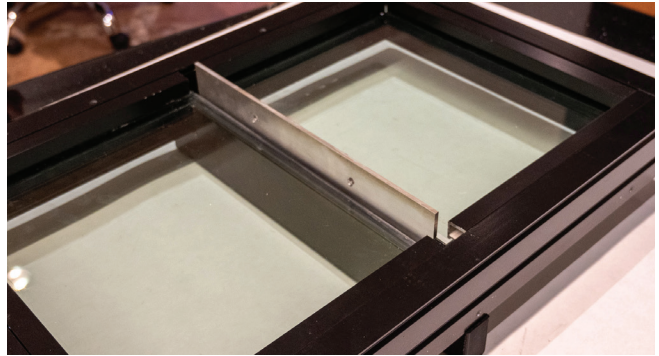

Interior Assembly Orientation

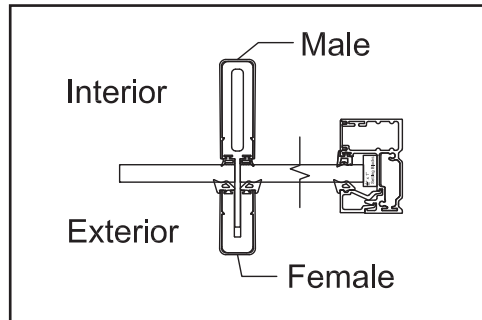

Exterior Assembly Orientation

### Step I.3 - Install Female Divider

Place female divider over the male divider and secure using 1/4-20 x 1 screws.

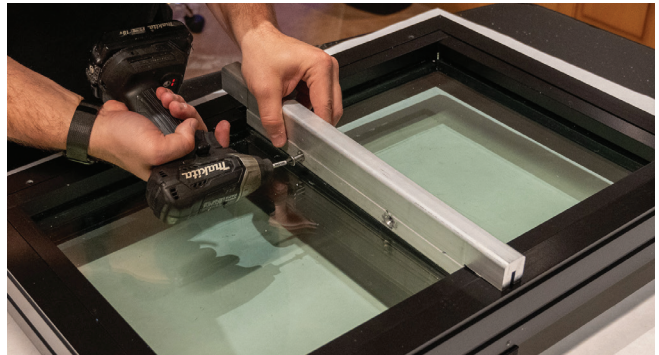

### Step I.4 - Install Female Divider Cover

Install the female divider covers. Ensure they snap in place.

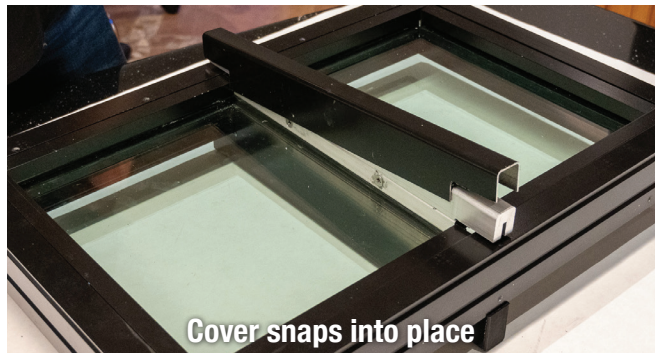

## J. Install Wedge Gasket

### Step J.1 - Install Wedge Gasket

Insert the wedge gasket between the glass and each section of the reducer/bead.



### Step J.2 - Install Divider Caps

Trim divider caps to size then use silicone to seal end caps to the top and bottom of each divider.

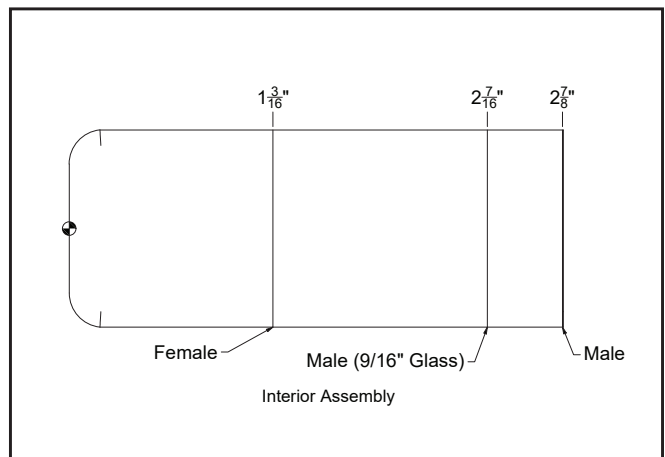
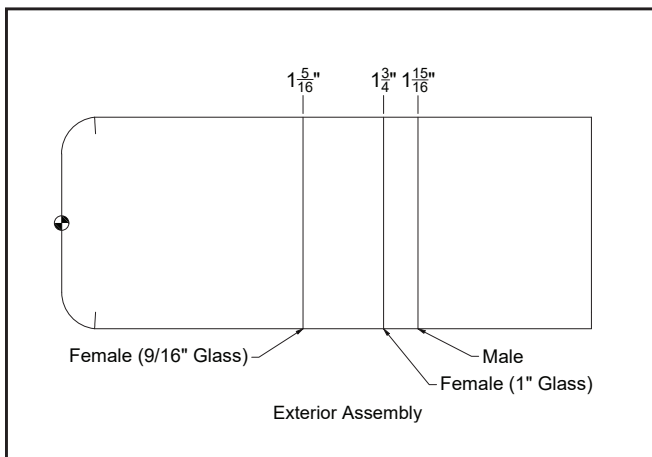
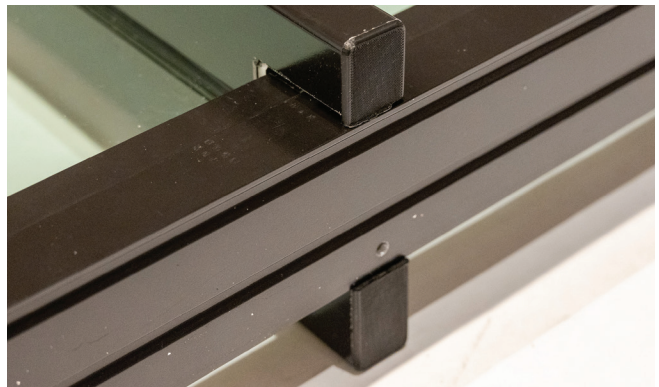

(1" Glass)

\*Approximate recommended trim lengths, actual lengths may vary per unit and per divider