



VISTA FOLD™ INSTALLATION GUIDE

Impact Rated

MANUFACTURING

2200 Murphy Court
North Port, Florida 34289
888.989.3876 • 941.979.5316

888.989.EURO (3876)
www.euro-wall.com

SHOWROOM

1211 Stirling Road, Unit 102,
Dania Beach, Florida 33004
954.610.2572

Important

Before beginning the install, read the instructions in their entirety. Perform install using the recommended methods contained within this guide. Deviating from recommended install procedures could impair functionality and could void any warranty.

Caution

It is the obligation of the building owner, contractor, architect or installer to ensure that door systems being installed comply with all building codes and regulations pertaining to the install location. Euro-Wall Systems, Inc. assumes no responsibility for failure to meet applicable laws, ordinances, building codes, etc.

Description of Supplied Parts

Upon delivery please inspect for any noticeable damage and check supplied materials with included packing list. If there is any damage and / or any missing components, please contact Euro-Wall as soon as possible. For installs with multiple opening units, do not mix and match any components even if the units are the same dimensions.

Protection of Unit During Construction

It is important that during the construction phase the door system components are protected and covered in a clean dry location away from any factors that could cause damage. Door systems that are stored during the construction phase can often times be exposed to situations that can cause permanent damage such as cement splatter, tar, paint, weld spray, falling objects, construction dust, sandblasting, etc. After installation of the door system is completed and construction is still being performed, ensure that the large opening where the door system is installed does not become a major in and out access point for contractors and subcontractors. Damage done during the construction phase can be irreparable and can cause significant setbacks with new panels needing to be constructed.

Panel Protective Film

If your project comes with protective film, remove all protective film from panels, frames and any other metal extrusion within 30 days of job delivery. Failure to do so could cause finish damage voiding the product warranty.

Considerations Before You Get Started

Space: Make sure you have the appropriate working space in and around the install opening. It is best practice to assemble the frame on top of saw horses (using at least four, one for each corner), therefore, make sure you have adequate room to assemble the frame in the area around the opening. Additionally, leave plenty of room without clutter to maneuver panels during install.

Power: Ideally power should be connected and accessible for tool operation and to ensure optimal lighting conditions for the install.

Moving Panels: Never “walk panels” and never try to move panels with only one person. Always lift and move panels by hand or using glass suction cups using at least two people. For installs less than 8’ in height, use a minimum of two installers. For panels over 8’ tall, a team of four is recommend for the install.

A. Tools Required

Step A.1 - Tools Checklist

Please make sure you have all of the required tools listed below before performing the install.

- | | | |
|--|--------------------------------------|---|
| ✓ Screw guns and chargers | ✓ 2', 4' and 6' levels | ✓ Glass cups for moving panels (min 4) |
| ✓ Extension bits Phillips #2 / #3 for tapcons | ✓ Pencil | ✓ Glazing bock (if ordered without glass) |
| ✓ Drill bits for steel, concrete and wood | ✓ Chalk line | ✓ Shop-Vac |
| ✓ 3/16", 1/4", 5/16", 3/4", and #29 drill bits | ✓ String line (for measuring square) | ✓ Ladder |
| ✓ 1/2" and 9/16" ratchet | ✓ Snips | ✓ Broom / dustpan |
| ✓ Hand screwdrivers (Phillips #2 and #3) | ✓ Utility knife | ✓ Garbage can / garbage bags |
| ✓ Rubber mallet | ✓ Tap measure | ✓ Copy of install guide |
| ✓ SDS gun | ✓ Saw horses (min 4) | |
| ✓ Laser level | ✓ Chop saw | |
| | ✓ Caulk gun | |
| | ✓ Pry bar or similar | |

Step A.2 - Disposables Checklist

Please make sure you have all of the required tools listed below before performing the install.

- | | | |
|--|---|-------------------------------|
| ✓ Tapcons (if drilling into concrete) | ✓ DOW 795 | ✓ Windex / glass cleaner |
| ✓ Screws for installing frame into substrate | ✓ Lubricant / wax | ✓ Clean rags |
| ✓ Caulk | ✓ Shims | ✓ Paper towels |
| ✓ 100% Silicone | ✓ Sill pan (width of the opening plus extra for play) | ✓ Cardboard / moving blankets |

Step A.3 - Labor Checklist

Please make sure you have the adequate number of installers

- | | |
|---|--|
| ✓ For installations with panels under 8 feet, recommended minimum of 2 installers | ✓ For installations with panels over 8 feet, recommended minimum of 4 installers |
|---|--|

NOTE: All Interior wood clad veneer products should be properly finished or sealed within 36 hours of delivery or stored in a climate controlled space until it can be properly finished or sealed.

B. Parts / Pieces Included

Below you will find a summary of the parts and pieces that are included with the door system. For a comprehensive checklist please see the packing list included with your order.

Step B.1 - Frame Checklist

- ✓ Jambs (2) (E0033)
- ✓ Header (1) (E0032)
- ✓ Frame weatherstripping (C0114)
see **Figure B.2**
- ✓ Sill (1) - standard (E0037), standard modified (E0034), channel(E0108) or ADA(E0028).
See **Figure B.1** below to identify the sill type used for this install
- ✓ Sill Liner (1) (C0083)

Step B.2 - Panel Checklist

Each system comes with a designated number of panels allocated in the work order. Each door panel must be installed in the correct sequence, please refer to the installation drawing and panel labeling for the correct install sequence.

- ✓ Panels (number designated by work order)
- ✓ Panel weatherstripping small (C0113) - see **Figure B.2** to distinguish between the two different weatherstripping types
- ✓ Panel weatherstripping large (C0112) - see **Figure B.2** to distinguish between the two different weatherstripping types
- ✓ If purchasing without glass, wedge gasket (C0020) will be provided - see **Figure B.2**
- ✓ Brush sweeps will be provided with standard modified, channel, and ADA sills.
3' (C0051), 4' (C0052), and 8' (C0053) are available.

FIGURE B.1: SILL TYPES

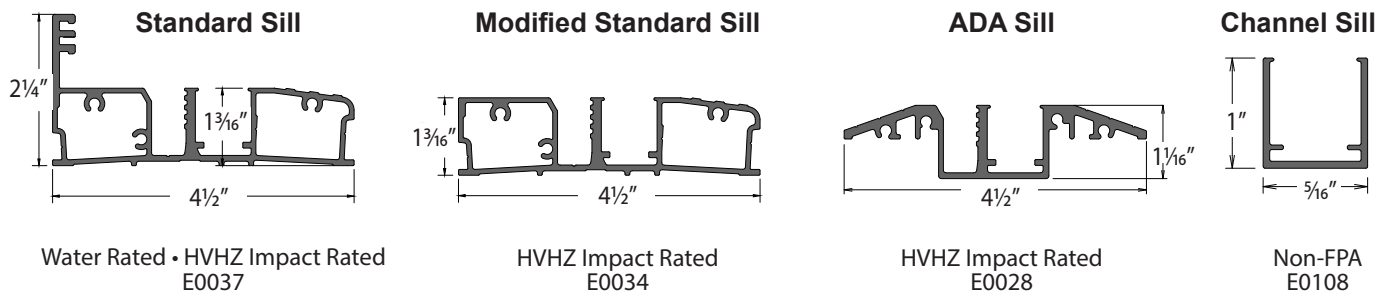

FIGURE B.2: GASKET PROFILES



Step B.3 - Hardware / Handles Checklist

NOTE: The hardware included with your install package will vary depending on the install configuration. Please check your parts packing list for the hardware & handles specifications for this installation.

LORI = Left Outswing / Right Inswing | ROLI = Right Outswing / Left Inswing

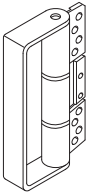

C0109
Straight
Pull Hinge

Package with Red Bag



C0095
D Pull
Handle

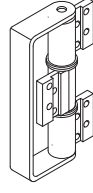

C0107
Modified
Pull Hinge

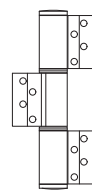

C0108
Straight
Hinge

Package with Red Bag

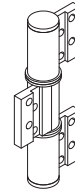

C0106
Modified
Hinge

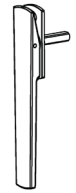

C0061
Removable
Twinpoint
Lever

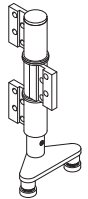

C0100
LORI Lower
Intermediate Carrier

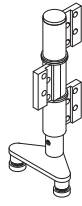

C0101
ROLI Lower
Intermediate Carrier

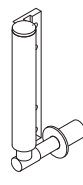

C0104 (hinge)
C0210 (cup)
LORI Center
Wall Pivot

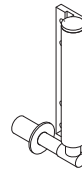

C0105 (hinge)
C0210 (cup)
ROLI Center
Wall Pivot

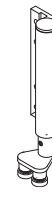

C0102
LORI Lower
Carrier

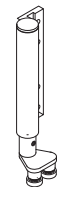

C0103
ROLI Lower
Carrier

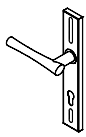

C0064
LORI Multipoint

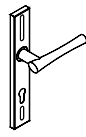

C0096
ROLI Multipoint



C0110
Magnetic
Door Catch

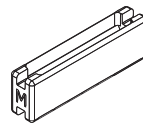

C0003
Multipoint Standard / Modified
Anti-Rattle Catch

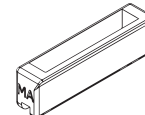

C0014
Multipoint ADA
Anti-Rattle Catch

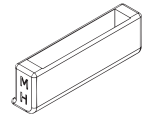

C0015
Multipoint Header
Anti-Rattle Catch



C0134
2.5 mm Allen Key

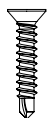

C0173
Sweep Screw



C0136
Jamb Anchor Screw



C0132
Hinge Screw



C0122
Frame Screw



C0333
Split Frame Adapter

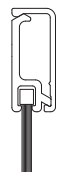

**Sweep
Cover**
3': C0051
4': C0052
8': C0053

Folding Door Installation Video Library



Scan the QR code or visit the link below to view the Folding Door Installation Video Library
www.tinyurl.com/2j6aenvt

VIDEO 1:
Measuring the Opening

VIDEO 2:
Frame Assembly Preparation

VIDEO 3:
Connecting Header (E0032)
to Jambs (E0033)

VIDEO 4:
Connecting Sill to Frame

VIDEO 5:
Drilling Weepholes

VIDEO 6:
Jamb Weatherstripping (C0114)

VIDEO 7:
Header Weatherstripping
(C0114)

VIDEO 8:
Sill Weatherstripping

VIDEO 9:
Dry Fitting the Frame

VIDEO 10:
Sealing the Sill Opening

VIDEO 11:
Securing the Sill

VIDEO 12:
Securing the Jambs (E0033)

VIDEO 13:
Securing the Header (E0032)

VIDEO 14:
Install the Center Wall
Pivot Cup (C0210)

VIDEO 15:
Preparing for Panel
Installation

VIDEO 16:
Moving Panels Properly

VIDEO 17:
Install the Center Wall Pivot
(LORI C0104, ROLI C0105)

VIDEO 18:
Installing the First Panel

VIDEO 19:
Second Panel Install
(Pt. 1)

VIDEO 20:
Second Panel Install
(Pt. 2)

VIDEO 21:
Attaching Hinges
with Astragal

VIDEO 22:
Install Panel
Weatherstripping (C0113)

VIDEO 23:
Making Vertical
Adjustments

VIDEO 24:
Horizontal Adjustments
(Pt. 1)

VIDEO 25:
Horizontal Adjustments
(Pt. 2)

VIDEO 26:
Installing Panel Sweeps
(3' C0051, 4' C0052, 8' C0053)

VIDEO 27:
Install Sill Liner (C0083)

VIDEO 28:
Installing Multipoint ADA
Anti-Rattle Catch (C0003)

VIDEO 29:
Installing Multipoint
Standard / Modified
Anti-Rattle Catch (C0003)

VIDEO 30:
Installing Multipoint Header
Anti-Rattle Catch (C0015)

C. Opening Preparation

Step C.1 - Measure, Level, Square & Clean

- ✓ Measure opening at least 3 points (see **Figure C.1**) to check for plumb, square and level of the opening
- ✓ Vacuum / sweep opening to be clear of dust / dirt / debris
- ✓ Ensure that there is only a maximum header deflection of 3/16" or less

FIGURE C1: MEASURING THE OPENING

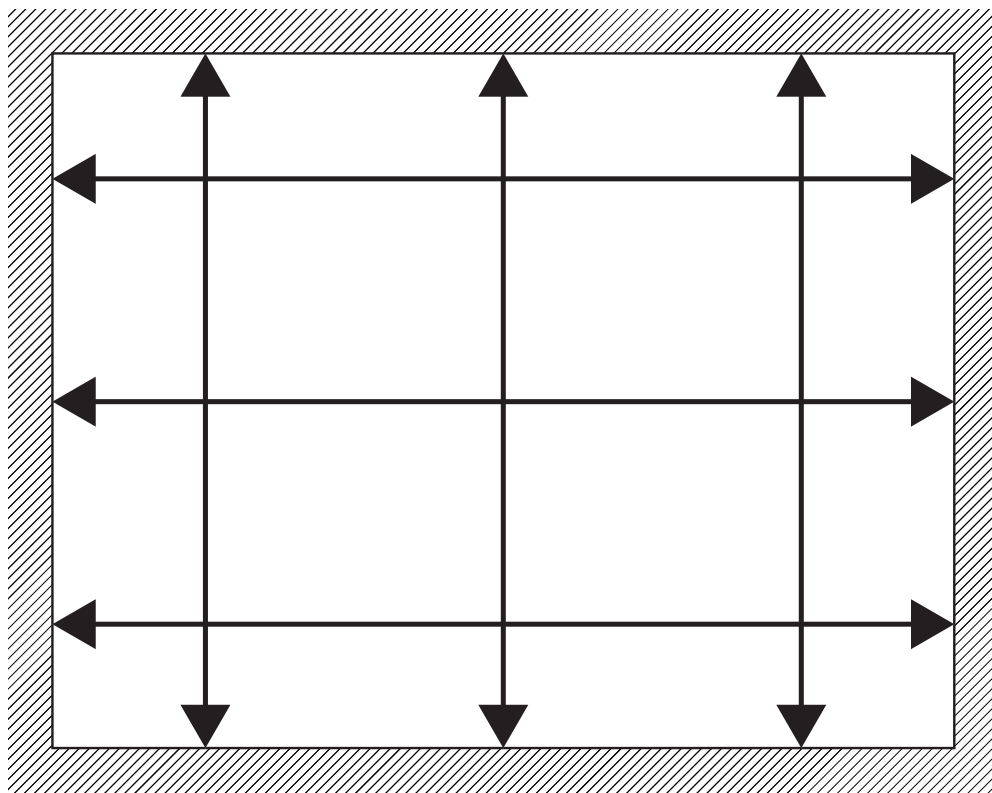

QR CODE: MEASURING THE OPENING



D. Embed Options with Water Management System

Figure D.1 - Embed Options Cross Sections with Water Management

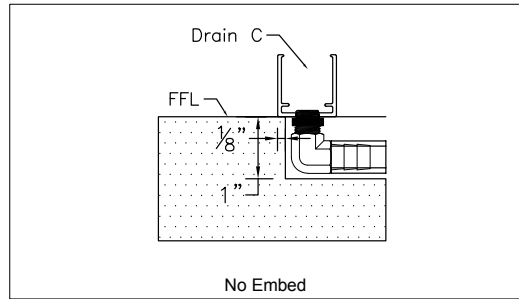
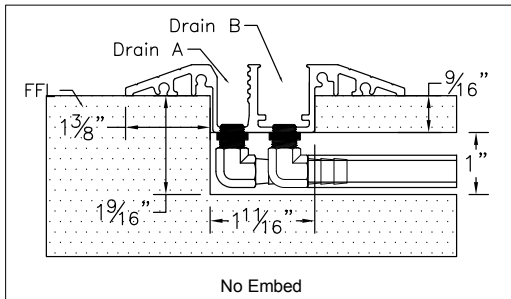
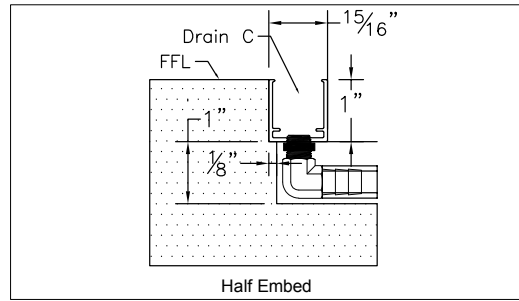
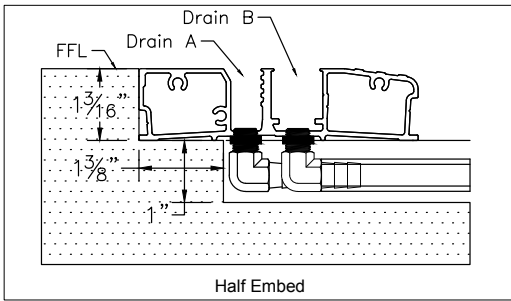
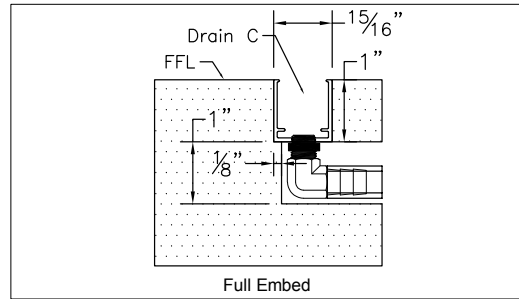
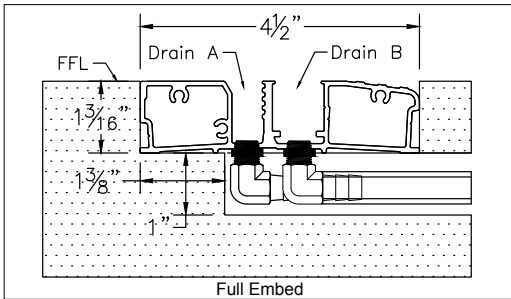

NOTE:
Water drainage tubes
not provided by
Euro-Wall Systems

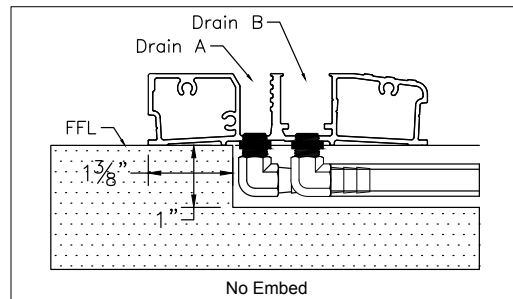

NOTE: Euro-Wall recommends using a sill pan for all door installations. Pan supplied by others.

E. Frame Assembly

Step E.1 - Frame Assembly Preparation

Place the frame as it will be assembled on 4 sawhorses near the opening. Sawhorses should be padded / wrapped to protect the frame from scratches or damage. **DO NOT ASSEMBLE FRAME ON THE GROUND.**

QR CODE: FRAME PREPARATION



Step E.2 - Connect Header (E0032) to Jambs (E0033)

Before assembling the frame, dip the frame screws (C0122) into wax or other lubricant. Seal the jambs (E0033) along the edge with 100% silicone. Align the jamb and header (E0032) together and connect securely with frame screws at the three pre-drilled locations. Drill at a moderate speed to avoid stripping or breaking screws. Repeat steps for other jamb.

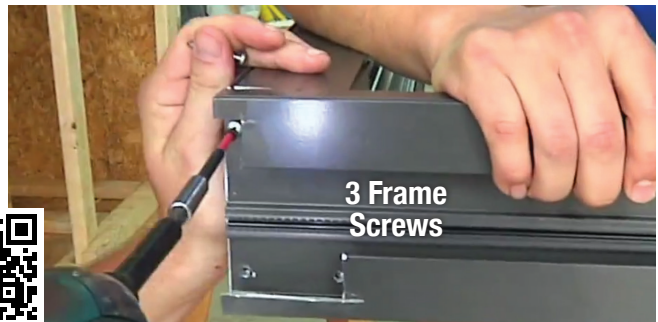
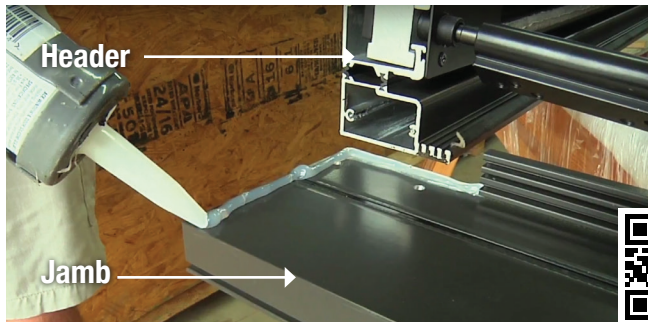

QR CODE: CONNECT HEADER TO JAMBS

Step E.3 - Connect Sill to Frame

Seal edge of sill with 100% silicone. Snug the jamb (E0033) to the sill and with waxed / lubricated frame screws (C0122), screw sill into the jamb into the four pre-drilled locations. Repeat steps for other side of the sill.

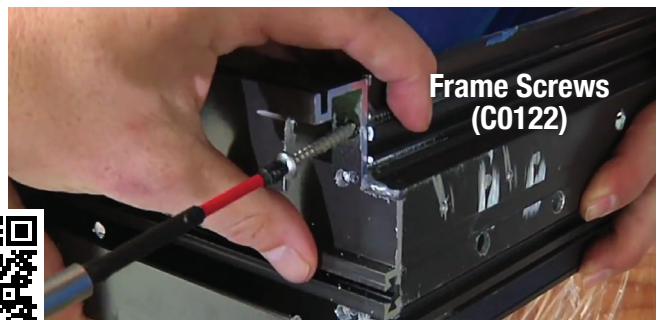

QR CODE: CONNECT SILL TO FRAME

Step E.4 - Connect Channel Sill (C0108) to Frame

Channel sills (C0108) do not need to be secured to the jambs with screws. Place your channel sill on the floor, butt it up against both jambs, and align with notch on jambs.

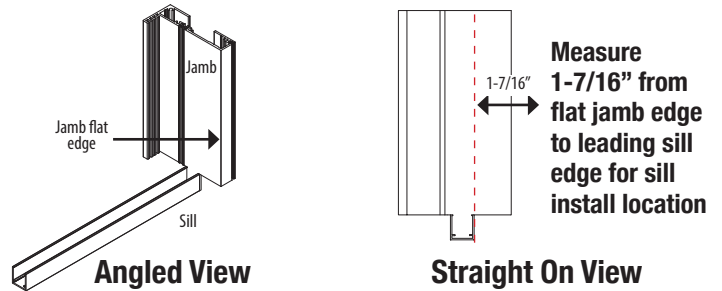

Step E.5 - Drill Weepholes through Sill

For half or no embed sill applications, 5/16" weepholes must be drilled through the face of the sill at the middle of every panel location. Drill the weepholes through the first chamber, through the roller track and into the twinpoint shootbolt track.

QR CODE: DRILLING WEEPHOLES



OUTSWING

INSWING

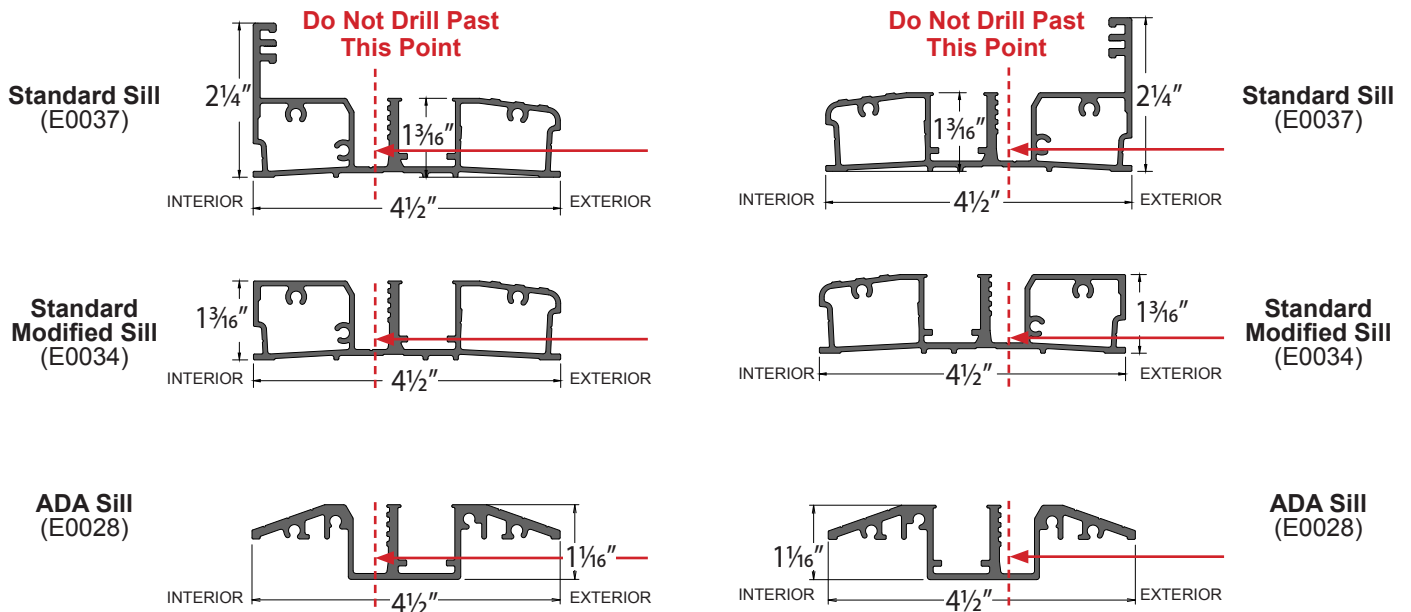

Channel Sill (E0108)

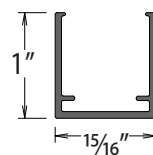

F. Frame Weatherstripping

Step F.1 - Install Frame Weatherstripping (E0114) into the Jamb

Place protruding end of weatherstripping into the first slot / groove of the jamb and push down to snug. Slide the weatherstripping all the way down to the sill snugging down the entire length of the jamb. Run over the entire weatherstripping to ensure a tight fit reaching the header. At the header location use snips and cut weatherstripping flush with the top against the header. Add a second piece of weatherstrip.

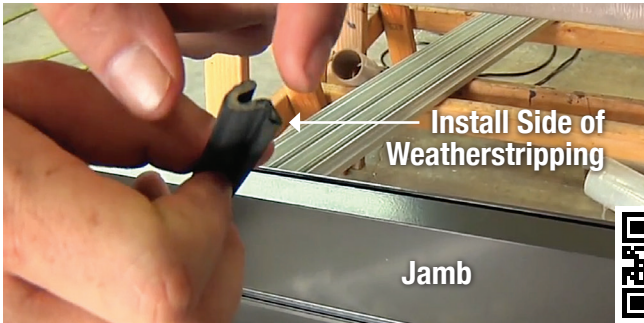

QR CODE: INSTALL JAMB WEATHERSTRIPPING

Step F.2 - Install Frame Weatherstripping (E0114) into Header

Following the same process used in installing the weatherstripping into the jamb, place protruding end of the weatherstripping into the first slot / groove of the header. Slide weatherstripping towards the jamb where the previously installed weatherstripping is. Move weatherstripping all the way to the jamb and over top of the jamb weatherstripping making sure they touch creating a seal. Trim to fit.

QR CODE: HEADER WEATHERSTRIPPING



Step F.3 - Install Weatherstripping (E0114) into Sill *(For Standard Sill Applications Only)

Install the weatherstripping on the top groove of the sill riser all the way across the sill touching both jamb side weatherstripping applications. Trim to fit with snips.

QR CODE: SILL WEATHERSTRIPPING



G. Dry Fit Frame

Step G.1 - Fit and Tack Frame into Place

Make sure opening is clean and clear of dirt / debris. Move frame into opening verifying opening is large enough. With the frame in position, temporarily tack into place through the jambs. All anchor screw locations on the frame come pre-drilled.

**QR CODE: ENTIRE
DRY FIT FRAME
PROCESS**



Step G.2 - Level & Plumb Frame

Check sill for level and plumb, shim where necessary. There should be no more than 1/16” sill sag at the center span of the sill. There should be no bow in the sill at any location.



Step G.3 - Pre-Drill Opening Substrate

Once the frame is shimmed and leveled, prepare the substrate by drilling through all frame anchor screw locations into the opening substrate where necessary. The type of drill bit used will vary depending on the substrate. Remove frame and vacuum / sweep clean of debris.



H. Install the Frame

Step H.1 - Sealing Sill Opening

Make sure opening is clean of all dirt and debris. Seal sill opening location with DOW 795 or 100% silicone. Place frame into opening and make sure the entire sill is embedded in the sealant.



QR CODE: SEALING SILL OPENING

Step H.2 - Securing the Sill

Position frame so that the jamb is plumb and level with adequate space for shimming and then tack into place. Follow the same steps for the second jamb. Proceed to securing the sill. Level the sill placing shims at least at every other pre-drilled anchor screw location and anywhere else shimming is needed. Dip screws in silicone and secure sill at every anchor screw location. Ensure that the sill remains level after every anchor location is secured and adjust as necessary.

QR CODE:
SECURING
THE SILL



Step H.3 - Securing the Jambs

Re-check jambs for level and plumb. Place shims behind every anchor screw location and screw jamb into place. Do not over tighten screws as this could cause the frame to bow. After screwing the jambs securely into the opening, check again for level and plumb.

QR CODE:
SECURING
THE JAMBS



Step H.4 - Securing the Header

Starting at either of the jambs, shim and secure the header into place proceeding down the entire length of the header checking for level with a two foot level. The screw used to secure the header must penetrate at least 1 1/2" into the opening substrate and the bolt head should not interfere with the door operation. Take care not to over tighten screws as this could cause the header to pinch creating door operation issues. After header is secured, re-verify level with a four foot level.

QR CODE:
SECURING
THE HEADER



NOTE: Material used to insulate the shim space between the frame and the opening should be a non-expandable material.

I. Install the Panels

Step I.1 - Install the Center Wall Pivot Cup (C0210) ONLY FOR PANELS OVER 72"

Locate the pre-drilled center wall pivot location on the jamb and using a 3/4" drill bit drill through the center wall pivot hole and into the opening substrate. Drill deep enough so that the center wall pivot cup can be seated.



NOTE: If the substrate you are securing into requires the use of tapcons, insert the center wall pivot cup into the jamb and use a 3/16" bit and drill through the pre-drilled hole in the back of the pivot cup and into the substrate.

QR CODE: INSTALL CENTER WALL PIVOT CUP



Apply a bead of silicone to the back edge of the center wall pivot cup and seat into the jamb. Screw center wall pivot cup into the opening substrate.

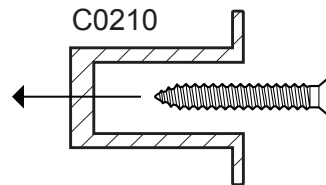

Step I.2 - Check Panel Install Sequence

Included with the installation material will be a document that labels the panels numerically looking from left to right from the exterior side of the opening. See below on the panel installation sequence.

Sequence for Split Configuration Opening

For split configurations start with the jamb connecting panel on the left side and install panels to where the split occurs. Then install panels on the opposite jamb connecting side and continue installing panels working towards the split until all panels are installed. The install sequence in the illustration below would be 1, 2, 3 then 5, 4.

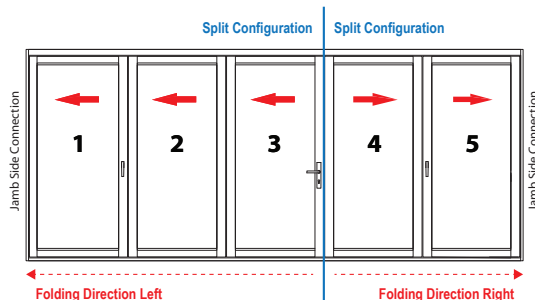

Sequence for Single Direction Opening

For openings with a single fold direction (either all panels folding to the left or all panels folding to the right) start installing panels at the jamb side connection first and install panels sequentially working back from the jamb. The sequence in the illustration below would be 1, 2, 3, 4, 5.

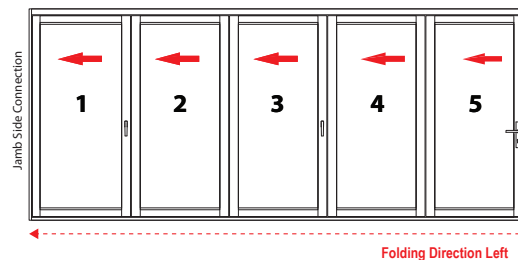

Step I.3 - Panel Installation Preparation

Before installing panels, place wood, protective foam, cardboard or other similar protectant over the sill to protect from damage during the panel installation process. Additionally, have a ladder near the panel installation for ease of installation.

Each door panel comes with its own clearly labeled box which includes all hinges, hardware and screws for that particular panel. Locate those and set aside. Move the first jamb panel into position for install. When moving panels, always move them with at least two people making sure to **NEVER walk the panels**. Walking panels could knock the panel out of square.

QR CODE:
PREPARING FOR
PANEL INSTALL



Incorrect

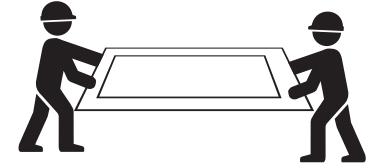

Correct

QR CODE: DON'T
"WALK" PANELS



Step I.4 - Attach the Center Wall Pivot to the Panel and Frame **ONLY FOR PANELS OVER 72"**

Using the hinge screws (C0132), attach the center wall pivot leaf (LORI C0104, ROLI C0105) to the panel. Next, position the panel by the jamb, and slide the center wall pivot into the center wall pivot cup (C0210).

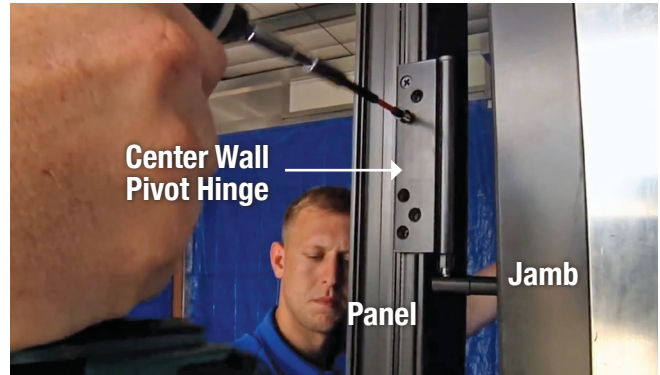
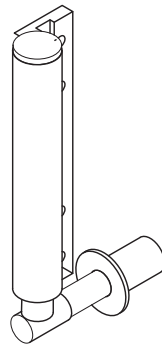

QR CODE:
INSTALL CENTER
WALL PIVOT



NOTE: Always support the weight of unsecured panels with a protected flat / pry bar or similar tool when installing or making adjustments.

Step I.5 - Attach the Upper and Lower Jamb Hinges

NOTE: All upper carriers and upper jamb hinges come pre-installed in the header track. Also, each upper carrier / upper jamb hinge has a 2.5mm set screw for making adjustments. It is recommended that each carrier rod be rotated so the set screw is visible facing away from the riser allowing easy access for adjustments. If set screw is not accessible, the corresponding panel will have to be removed when making panel adjustments.

Attach the Upper Jamb Hinge (LORI C0069, ROLI C0070)

Align the upper jamb hinge with the pre-drilled hinge holes on the panel. You may need to adjust the upper jamb hinge up or down. The clearance of the panel and header should be no more than 3/8". To adjust the upper jamb hinge, use the provided 2.5mm allen key (C0134) to loosen the allen bolt on the upper jamb hinge. Then use a 1/2" or 9/16" ratchet with an extension to raise or lower the upper jamb hinge to align with the panel hinge holes. **Please see section L** of this document for more details on making adjustments.

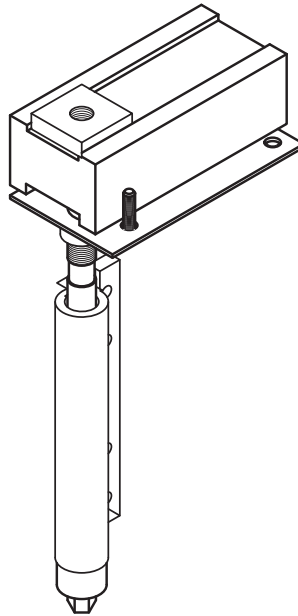

After holes are aligned, re-tighten the allen bolt and attach the upper jamb hinge to the panel with the hinge screws (C0132).

QR CODE: INSTALL
THE FIRST PANEL



Attach the Lower Jamb Hinge (LORI C0071, ROLI C0072)

Align the lower jamb hinge holes with the pre-drilled hinge screw holes on the frame and attach using the hinge screws (C0132). After the first jamb panel is installed, slowly open and close the panel making sure the panel does not rub against the header or the sill. Adjust as necessary.

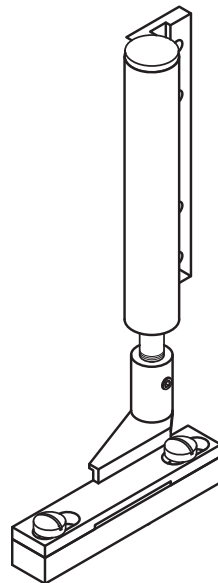

J. Install the Second Panel

Step J.1 - Attach Second Panel to First Panel

First, locate the hardware box for the second panel and attach the corresponding hinges to the first / previous panel. Installing the second panel hinges to the first / previous panel provides a stable and easier method of attaching panels by installing the hinges to the previous panel first. Move the second panel into position adjacent to the first panel and align the top hinge on the first panel to the pre-drilled holes on the second panel. Do not try and force the hinge screws (C0132) into the hinge before the hinge holes are aligned; this can cause the hinge to bend. Use a protected pry bar or shims to align screw holes. When aligned, attach using hinge screws (C0132). Repeat the previous steps to attach the remaining hinges to the second panel.

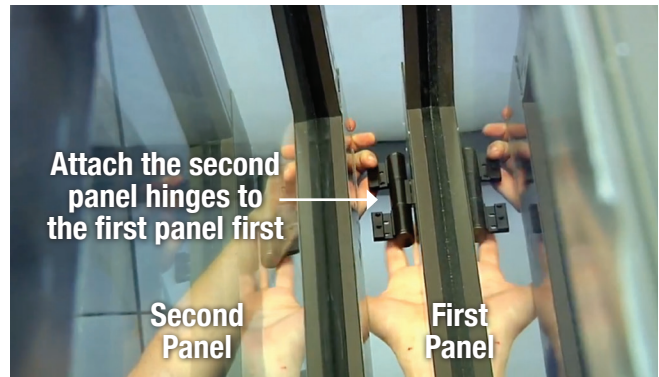

QR CODE: SECOND PANEL INSTALL PART 1



NOTE: Hinge layout can be found with the installation package provided.

Step J.2 - Attach Carriers to Second Panel

Attach the carrier to the second panel. Slide the pre-installed carrier over to the second panel. If the carrier hinge holes do not align with panel hinge holes, use your 2.5mm allen key (C0134) to loosen the carrier allen bolt and adjust the bottom carrier bolt up or down to align using a 1/2" or 9/16" ratchet. Once aligned, re-tighten the allen bolt on the carrier. **Please see section L** of this document for more details on making adjustments. Attach the hinge to the top of the panel using hinge screws (C0132).

Next, attach the lower intermediate carrier to the second panel using the hinge screws (C0132).

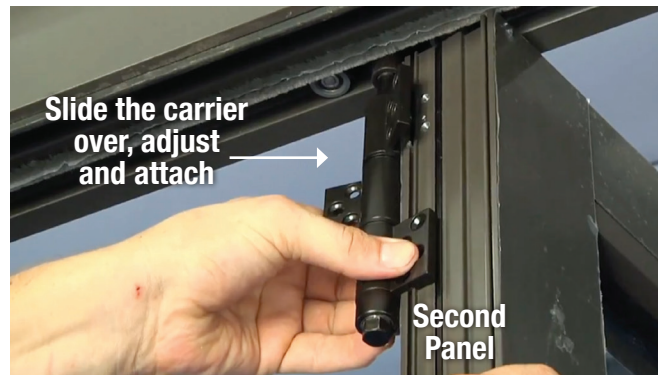

QR CODE: SECOND PANEL INSTALL PART 2



Part Reference:

LORI Upper intermediate carrier: C0065
 LORI Lower intermediate carrier: C0100
 ROLI Upper intermediate carrier: C0066
 ROLI Lower intermediate carrier: C0101

(Used at the end of even panel components)

LORI Upper Carrier: C0067
 LORI Lower Carrier: C0102
 ROLI Upper Carrier: C0068
 ROLI Lower Carrier: C0103

Step J.3 - Attach Hinges to Panels Containing an Astragal

Remove the astragal from the stile and set aside. Slide the carrier to the panel and install per the methods discussed previously in sections J.1 / J.2. After the upper and lower carriers are installed, replace the astragal onto the stile. If no astragal is present, move on to the next step.



QR CODE: ATTACH HINGES TO PANELS WITH ASTRAGALS



Step J.4 - Attach Remaining Panels

Following the previous steps laid out for installing the first and second panels, all panels should be installed using the same methods.

K. Install Panel Weatherstripping

Step K.1 - Weatherstrip Profiles and When / Where to Apply

There are two different types of panel weatherstripping. We will reference these two different profiles as “small p weatherstripping” (C0113) and “large p weatherstripping” (C0112). **The large p weatherstripping always gets installed on the panel edges that have two modified hinge leaves.** The small p weatherstripping goes on panel edges that have one straight or modified hinge leaf. When installing either weatherstripping profile the large side of the weatherstripping should face out towards the edge of the panel stile.

The large p weatherstripping also goes on the jamb side panel edges.

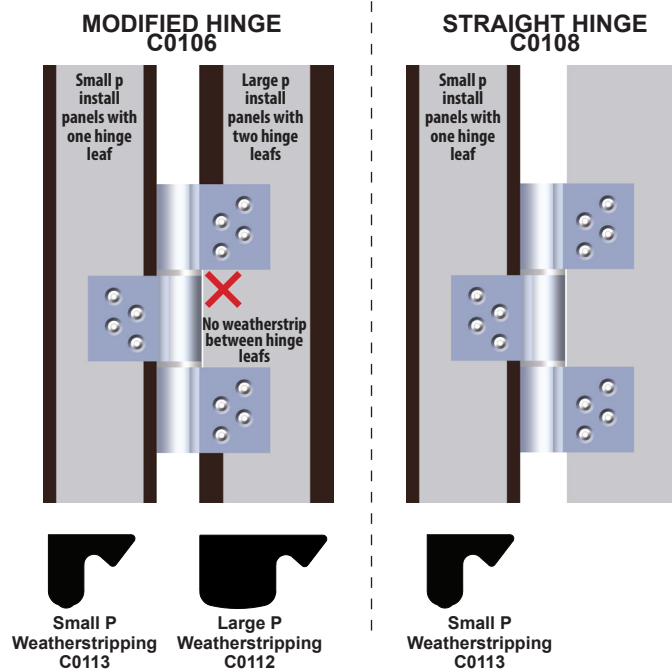

QR CODE: INSTALLING PANEL WEATHERSTRIPPING



NOTE: Check your hardware box sheet to verify if your door system uses straight hinges (C0108).

L. Horizontal / Vertical Adjustments

Step L.1 - Vertical Adjustments

To adjust the vertical alignment of your panel, you must first locate and loosen the set screw on the upper carriers, intermediate carries, or jamb hinges (*Refer to J.2 for all applicable part numbers*). With a 2.5mm allen key (C0134) loosen the set screw and adjust the drop down carrier pin bolt by using a 1/2" or 9/16" socket ratchet. Adjusting the dropdown carrier bolt will raise or lower the panel. Once the appropriate vertical adjustment has been made - re-tighten the set screw.

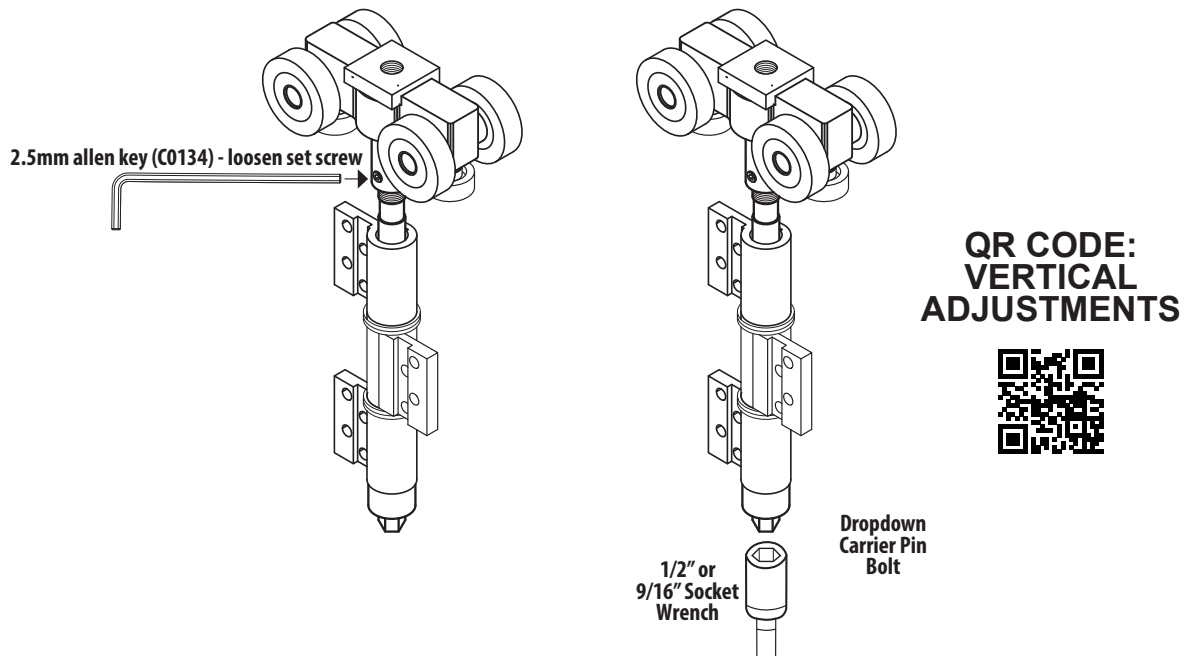

Step L.2 - Horizontal Adjustments

Upper Jamb Hinge Adjustment. To adjust the horizontal alignment of your panel, you must first locate and loosen the set screw on the upper jamb hinge(s) with a 2.5mm allen key (C0134). Next, loosen the two adjustment screws. You may now move the upper jamb hinge horizontally to the desired location. Once the appropriate horizontal adjustment has been made - re-tighten adjustment screws.

After final adjustment is set and the adjustment screws are tightened, drill a hole through **only ONE of the back facing screw hole locations on the upper jamb plate**. Only drill enough to punch through the header making sure to not drill through the upper jamb hinge block. Secure position with a hinge screw (C0132). **DO NOT** install a second screw at the other location. You will use that in the situation where a second adjustment needs to be made in the future.

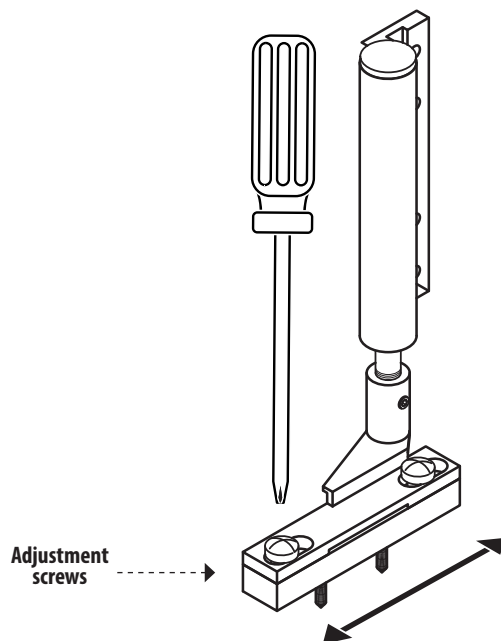
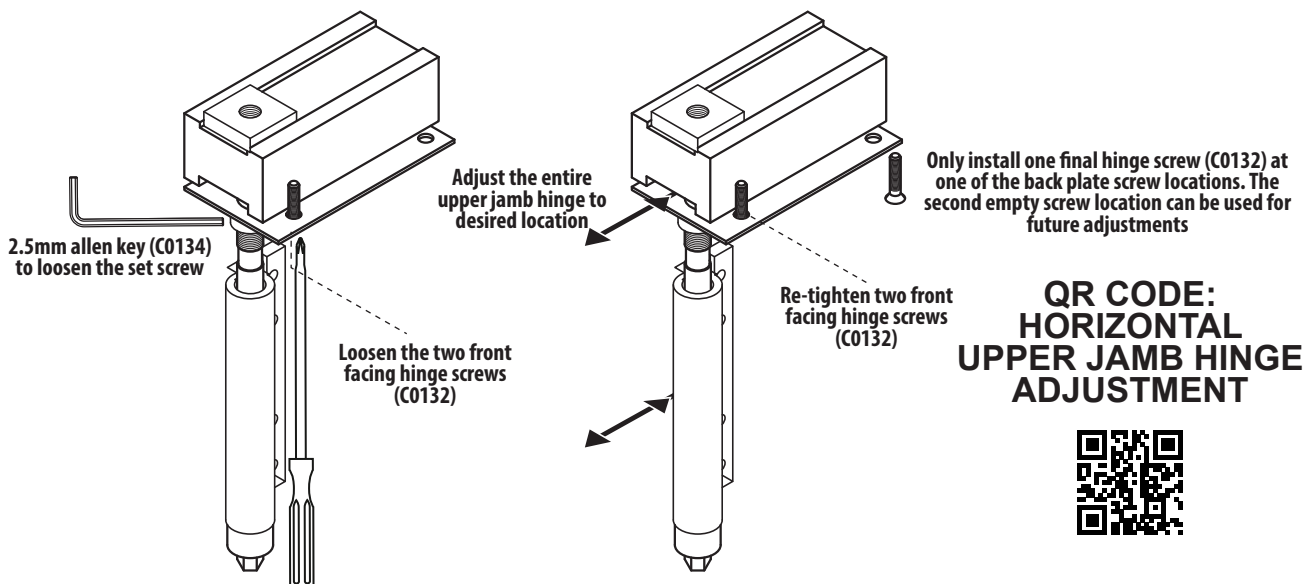

Lower Jamb Hinge Adjustment. Loosen the adjustment screws on the lower jamb mounting hardware and move the lower jamb hinge to the desired position. Once the appropriate horizontal adjustment has been made - re-tighten the adjustment screws.

M. Install Sweeps

3' (C0051), 4' (C0052), 8' (C0053) are available Step M.1 - Measuring / Cutting Sweeps

Disassemble the sweep - remove the sweep cover plate and remove the bristles. Measure the cut length required for the sweep. For sweeps that run up against a bottom carrier hinge you want to leave an 1/8" gap between the sweep edge and the hinge edge. Neglecting to do so will cause the sweep to rub against and scratch the hinge when the door is opened / closed.

For adjoining panels with no connecting bottom carrier hinges you will have a small gap between the panels. You want to mark your sweep for cutting past the panel edge and splitting the difference of the panel to panel gap. That way your sweeps will meet / touch when the door system is closed.

After marking your cut locations, cut your sweep and your sweep cover using a chop saw. Cut the sweep bristles using snips or a grinder making sure that the bristles do not fray. Reassemble the sweep and the bristles.

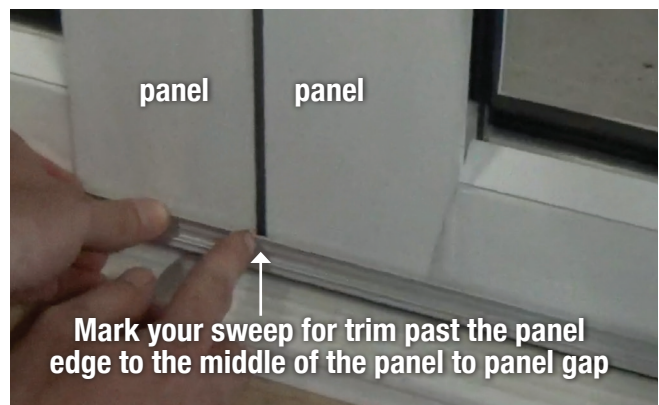
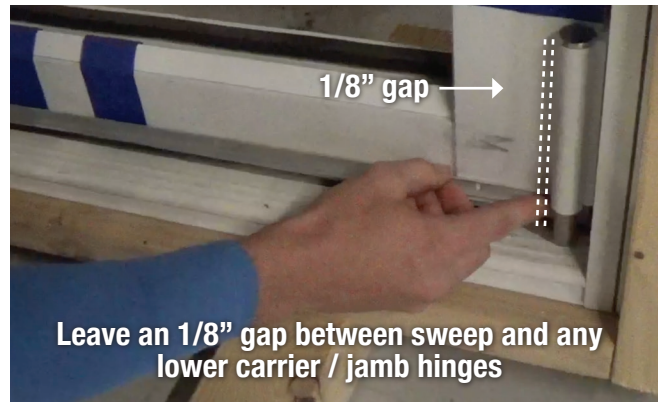

Step M.2 - Install Sweep

Place sweep into position on the bottom rail of the panel until the sweep is just touching the sill and then compress the sweep down until no daylight shows between the panel and the sill. When securing the sweep to the panel you can use the pre-drilled hole locations on the sweep or you can drill your own holes. Each panel has a corner key which extends from stile 4" into the bottom rail - make sure not to screw into these areas. Start from left to right and secure the sweep into place using provided sweep screws (C0173). Install the sweep cover by snapping into place or by using a rubber mallet.



QR CODE: INSTALLING
SWEEPS FULL VIDEO



N. Install Sill Liner (C0083)

Step N.1 - Install

The next step in your installation will be installing the sill liner (C0083) which covers the anchor screws in the sill. **If your install requires an inspection, DO NOT INSTALL SILL LINER UNTIL AFTER THE INSPECTION.** Once the sill liner is installed, it will need to be cut in order to remove it.

Measure and cut your sill liner to length. Starting at either jamb side, push one end of the sill liner into the sill channel until it snaps snugly into place. Slide the sill liner underneath the bottom jamb hinge. You may now continue to push the rest of the sill liner into the sill channel by hand or with a rubber mallet.



QR CODE: INSTALLING THE SILL LINER



O. Anti-Rattle Components (If Applicable)

Step O.1 - Types of Anti-Rattle Components

If your opening has a multipoint locking handle that secures to an astragal panel, you'll need to install the anti-rattle header and sill components. If your opening contains a multipoint locking handle that secures into the jamb or does not have a multipoint locking handle you will not need to install the anti-rattle components. There are three different types: "MA" for an ADA sill (C0014), "M" for a standard/modified sill (C0003) and "MH" for the header (C0015).

Step O.2 - Install Multipoint ADA Anti-Rattle Catch (C0014)

If you have an ADA sill you will be installing the multipoint ADA anti-rattle catch (C0014). (See **Figure B.1** to reference which sill type you have.) Mark the spot with pencil on your sill where the multipoint shootbolt engages. Center the catch along the marked location in the thinner of the two channels in your sill. This should be the channel your carrier hinges do not move across. Line the side of the catch with silicone and push down until the catch snaps in place.

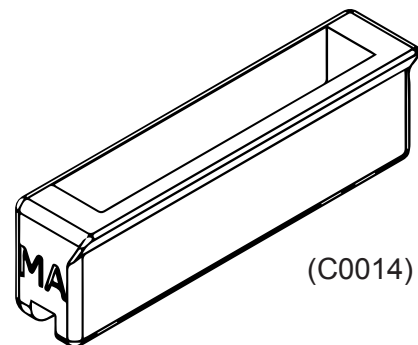

QR CODE: INSTALLING MULTIPOINT ADA ANTI-RATTLE CATCH



Step 0.3 - Install Multipoint Standard/ Modified Anti-Rattle Catch (C0003)

If you have a standard or modified standard sill you will be installing the multipoint standard/modified anti-rattle catch (C0003). (See **Figure B.1** to reference which sill type you have.) Mark the spot with pencil on your sill where the multipoint shootbolt engages. Center the catch along the marked location in the thinner of the two channels in your sill. This should be the channel your carrier hinges do not move across. Line the side of the catch with silicone and push down until the catch snaps in place. The arrow on the opposite side of the “M” should be facing outward with an outswing or facing in with an inswing.

**QR CODE: INSTALLING
MULTIPOINT STANDARD /
MODIFIED ANTI-RATTLE CATCH**

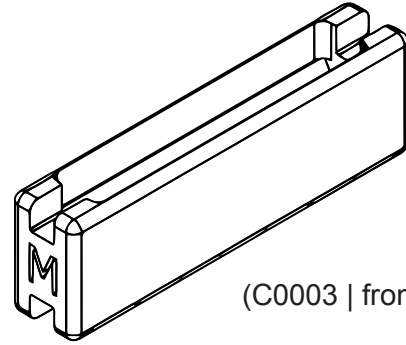

(C0003 | front side)

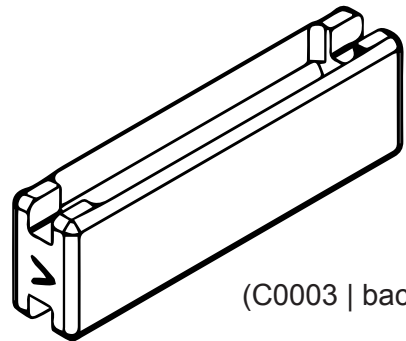

(C0003 | back side)

Step 0.4 - Install Multipoint Header Anti-Rattle Catch C0015

The multipoint header anti-rattle catch (C0015) will be installed into your header. Mark the spot with pencil on your header where the multipoint shootbolt engages. Center the catch along the marked location in the thinner of the two channels in your header. This should be with channel without hinges. Line the side of the catch with silicone and push up the catch up into place.

**QR CODE: INSTALLING
MULTIPOINT HEADER ANTI-
RATTLE CATCH**

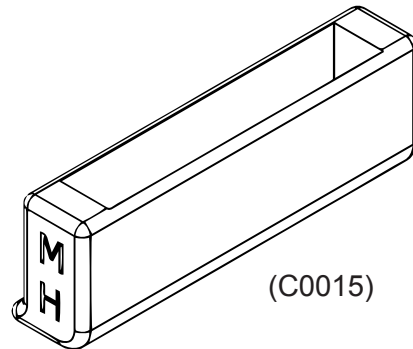

(C0015)

P. Magnetic Door Catch (C0110, Swing Panels Only)

Step P.1 - Install

If your unit has a swing panel, you will be provided a magnetic door catch (C0110) kit. Ensure Step M. Install Sweeps (if applicable) has been completed before proceeding. The magnetic door catch should sit between the sweep (if present) and the snap bead. Mark the horizontal center of the top or bottom rail on the **swing panel**. Assemble the first magnet housing by inserting one magnet face-down so it protrudes slightly, then seating two springs into the back. Align the magnet and housing at the center-of-rail mark and pre-drill the hole locations using a #29 bit. Then, install the housing with the provided screws. For the second housing, attach its magnet to the installed magnet and open the panel to its intended position. Mark through one of the housing holes where the magnet contacts the adjacent panel's rail. Drill the hole at that location. Then, place the remaining springs into the back of the second housing and install with one screw into the pre-drilled hole. Swing the panel open to confirm alignment before drilling the second hole and driving the final screw. Press the cover plates on with "Centor" readable from the top. Test by opening and closing the panel to confirm the handle clears without contact.

QR CODE: INSTALLING
MAGNETIC DOOR CATCH

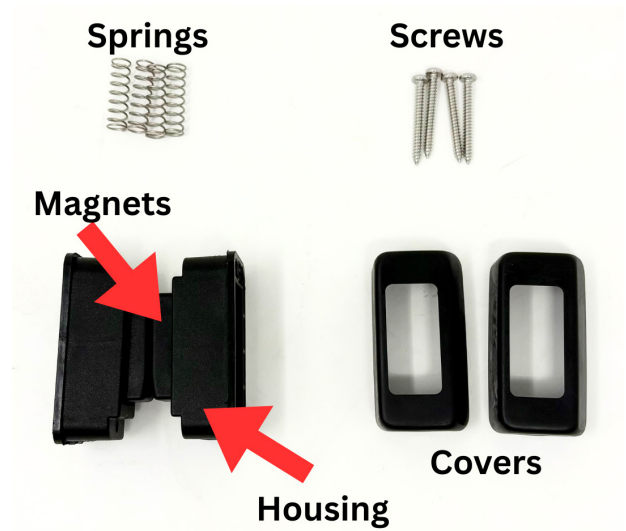

Q. Maintenance & Care

Sash Protective Film

Remove all protective film from sashes, frames and any other metal extrusion within 30 days of job delivery. Failure to do so could cause finish damage voiding the product warranty.

Hinges

Wipe down the visible surfaces with warm soapy water on a soft cloth and then rinse off by wiping with a clean damp cloth.

Locks and Hardware

Wipe down the visible surfaces with warm soapy water on a soft cloth and then rinse off by wiping with a clean damp cloth. Spray a thin film of Boeshield T-9 (or other corrosion preventative spray such as CRC Marine 66, Inox or CorrosionX, or with machine oil) on any exposed hardware, including but not limited to: handles, locking mechanisms, hinges, unpainted or uncoated metal components, brackets, bearings, exposed screws etc. Be careful to avoid overspray and be sure to wipe down any overspray that does occur. Take care to avoid spray onto wood components, as staining may occur. Use a soft cloth to buff out any excess residual film.

Track and Bearings

Apply white petroleum jelly (Vaseline) or equivalent, to inner lip of each side of head track with a clean cloth. Distribute lubricant evenly along track. Ensure wheels and bearings receive sufficient lubricant.

Wipe all contaminant from track surfaces with damp cloth and mild detergent, clean surfaces with clean soft cloth. Apply thin film for systems installed in severe environments by wiping surfaces of track with anti-corrosive substance, such as, Boeshield T-9, CRC Marine 66®, Inox® or CorrosionX®.

Hangers, Pivots and Brackets

Before applying anti-corrosive substance, wipe exposed surfaces with clean soft cloth soaked in warm soapy water; then rinse, clean and dry. Spray thin film to hangers, pivots and brackets with anti-corrosive substance, such as, Boeshield T-9, CRC Marine 66®, Inox® or CorrosionX® and wipe off any overspray or excess residual film with a soft cloth.

Frequency

Regular maintenance is required for all hardware, even stainless steel, to keep manufacturer's warranty in place. Failure to provide proof of maintenance will void any warranty.

Carry out maintenance procedures with the following minimum recommendations:

- General environments - every 3 months
- Marine, industrial environments, within 5 miles of a body of water and / or a pool area - every month.
- Boeshield T-9 re-application: every 6 months for general environment, and up to every 3 months for marine/industrial environments, or within 5 miles of a body of water and/or a pool area.

NOTE: Maintenance is required to extend the life of your door system and to maintain the Euro-Wall Warranty