



Vista Thin Line™



IMPACT & NON-IMPACT RATED
Thin Line Window System



#FL47174
V2. 032026

Refined with No Lines



Introducing Vista TL™, our visionary new product line of thin line windows, designed to seamlessly blend architectural elegance and performance. Featuring edge-to-edge glass glazing with zero obstructive sightlines, these glass wall window systems provide an uninterrupted view that maximizes natural light and showcases your space like never before.

It's the perfect choice for any project, combining personal support with cutting-edge design.

Features & Benefits

Zero Obstructions

Enjoy edge-to-edge glazing with no dividing mull, minimal 2" frames and unlimited lites for an expansive view.

Uniform Aesthetics

Design complete, whole-home packages using our sliding, folding, pivot, casement, fixed, and stacking door and window systems for a harmonious appearance.

Larger & Stronger Window Capabilities

Enjoy the view through some of the largest systems in the industry (Up to 16-1/2' tall and wide for a single glass lite with an unlimited number per opening).

Layer On the Protection

Provide superior impact protection with our minimal 1-1/8" glass makeup and a wind load rating of up to 90 DP.

Always Here for You

Experience our comprehensive white-glove sales and installation support, ensuring every detail is expertly handled from start to finish for a flawless, worry-free service.

System Thresholds

MAXIMUM / MINIMUM SPECIFICATIONS

SINGLE UNIT HVHZ & WZ3

	IMPACT RATED
MAX. FRAME HEIGHT	198"
MAX. FRAME WIDTH	198"
MIN. FRAME HEIGHT	18"
MIN. FRAME WIDTH	18"

MAX. FRAME HEIGHT

MAX. FRAME WIDTH

MIN. FRAME HEIGHT

MIN. FRAME WIDTH

Note: The height and width are interchangeable to accommodate vertical or horizontal arrangements.

MULTIPLE UNITS

	HVHZ	WZ3
MAX. FRAME HEIGHT	144"	198"
MAX. DLO WIDTH	194"	194"
MIN. FRAME HEIGHT	18"	18"
MIN. DLO WIDTH	18"	18"

MAX. FRAME HEIGHT

MAX. DLO WIDTH

MIN. FRAME HEIGHT

MIN. DLO WIDTH

Note: For installations in Florida, please see the Florida Product Approval (FL47174) for usage and limitations.



10-Year Limited Warranty

Euro-Wall warrants the products to be free from manufacturing defects for a period of 10 years.



DESIGN PRESSURE CHART (SINGLE UNIT)

HVHZ & WZ3

Frame Width

Frame Height	60	72	84	96	108	120	132	144	156	168	180	192	198
60	90	90	90	90	90	90	90	90	90	90	90	90	90
72	90	90	90	90	90	90	90	90	90	90			
84	90	90	90	90	90	90	90	90					
96	90	90	90	78.4	78.4	78.4							
108	90	90	90	78.4	69.5								
120	90	90	90	78.4									
132	90	90	90										
144	90	90	90										
156	90	90											
168	90	90											
180	90												
192	90												
198	90												

DESIGN PRESSURE CHART (MULTI-UNIT & CORNERS)

HVHZ & WZ3

DLO Width

Frame Height	26	38	50	62	68	80	86	98	110	116	128	140	146	164	176	194
60	90	90	90	90	90	90	90	90	90	90	90	90	90	90	90	90
66	90	90	90	90	90	90	90	90.0	90	90	90	90	90	90	90	
72	90	90	90	90	90	90	90	90.0	90	90	90	90	90	90	90	
78	90	90	90	90	90	90	90	90.0	90	90	90	90	90	90	90	
84	90	90	90	90	90	90	90	90.0	90	90	90	90	90	90	90	
90	90	90	90	90	90	90	90	90.0	83.8	83.8	83.8	83.8	83.8	83.8	83.8	
96	90	90	90	90	90	90	90	83.8	78.5	78.5	78.5	78.5	78.5	78.5	78.5	
102	90	90	90	90	90	90	90	83.8	73.7	73.7	73.7	73.7	73.7	73.7	73.7	
108	90	90	90	90	90	90	90	83.8	73.7	73.7	73.7	73.7	73.7	73.7	73.7	
114	90	90	90	90	90	90	90	83.8	73.7	73.7	73.7	73.7	73.7	73.7	73.7	
120	90	90	90	90	90	90	90	83.8	73.7	73.7	73.7	73.7	73.7	73.7	73.7	
126	90	90	90	90	90	90	90	83.8	73.7	73.7	73.7	73.7	73.7	73.7	73.7	
132	90	90	90	90	90	90	90	83.8	73.7	73.7	73.7	73.7	73.7	73.7	73.7	
138	90	90	90	90	90	90	90	83.8	73.7	73.7	73.7	73.7	73.7	73.7	73.7	
144	90	90	90	90	90	90	90	83.8	73.7	73.7	73.7	73.7	73.7	73.7	73.7	
150	90	90	90	90	90	89.1	89.1	89.1	89.1	89.1	89.1	89.1	89.1	89.1	89.1	
156	90	90	90	84.6	84.6	84.6	84.6	84.6	84.6	84.6	84.6	84.6	84.6	84.6	84.6	
165	90	90	81.1	81.1	81.1	81.1	81.1	81.1	81.1	81.1	81.1	81.1	81.1	81.1	81.1	
180	90.0	84.6	65.3	65.3	65.3	65.3	65.3	65.3	65.3	65.3	65.3	65.3	65.3	65.3	65.3	
192	90.0	69.3	69.3	69.3	69.3	69.3	69.3	69.3	69.3	69.3	69.3	69.3	69.3	69.3	69.3	
198	90.0	63.0	63.0	63.0	63.0	63.0	63.0	63.0	63.0	63.0	63.0	63.0	63.0	63.0	63.0	

Test Performance

Air Infiltration: ASTM E283/E283M-19

Water Infiltration: ASTM E331-00

Wind Load: TAS 202-94

Large Missile Impact: TAS 201-94, ASTM E1996-20

Cyclic Load: TAS 203-94, ASTM E1886-19

Product Approval: FL47174

Glazing Details

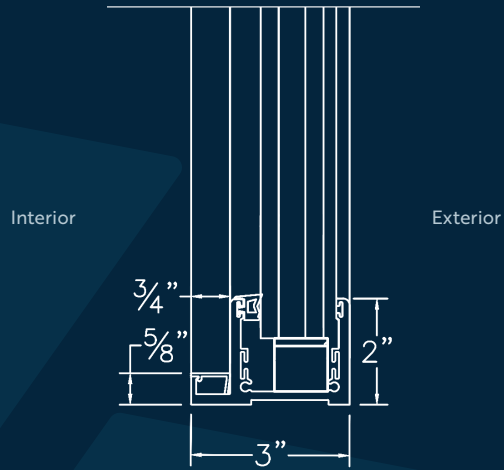

OVERALL GLASS THICKNESS

1-1/8"

Frame: E0001

Finish Options

STANDARD FRAME & DOOR PANEL FINISHES

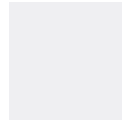

White
UC40577



Bronze
UC91252



Black
UC40577



Clear
Anodized

Note: Standard finish is Kynar® AAMA 2605. Additional custom powder coat or Kynar® finishes available upon request.

STANDARD INTERIOR WOOD CLAD FINISHES



Mahogany /
Sapele



White Oak

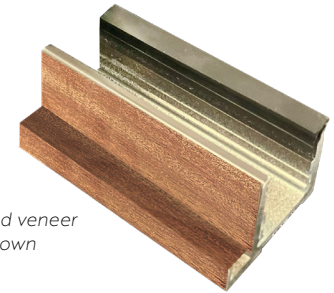

Wood clad veneer
option shown

EXOTIC INTERIOR WOOD CLAD FINISHES



Ash



Birch



Curly Maple



Red Oak

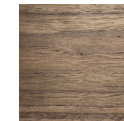

Walnut

Note: Additional exotic wood finish options available upon request.

FAUX WOODGRAIN FINISHES



Aspen

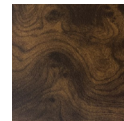

Burlwood

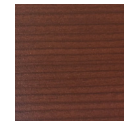

Chesnut Cherry

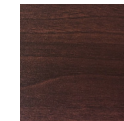

Cinnamon Red

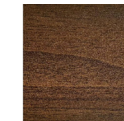

Dark Walnut



English Oak

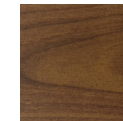

Hazelnut Brown



Honey Pine

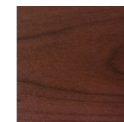

Mahogany Red

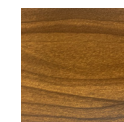

Natura

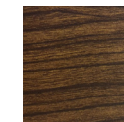

Teak

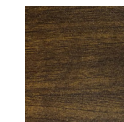

Walnut Brown

Note: A faux woodgrain finish is a powder coat with die sublimation to an AAMA 2604 finish qualification. Additional faux woodgrain options available upon request. The colors shown are an approximation of actual colors and finishes, actual finishes may vary slightly.

Multi-Unit CAD details

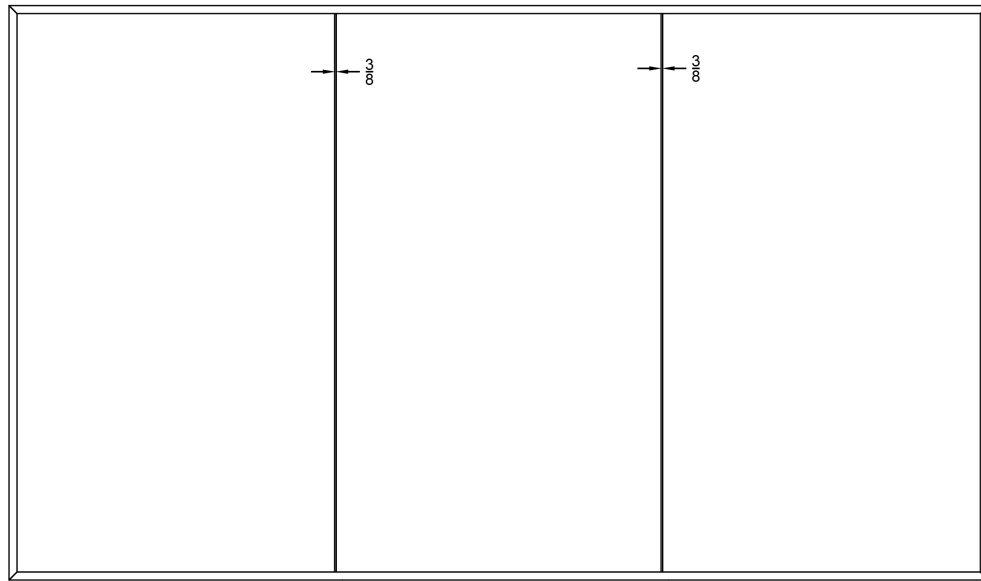

Exterior Front Elevation

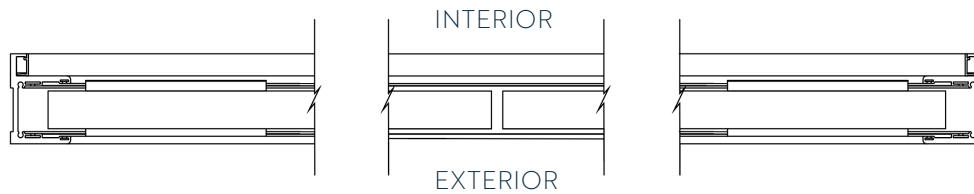

Top Down Cross Section

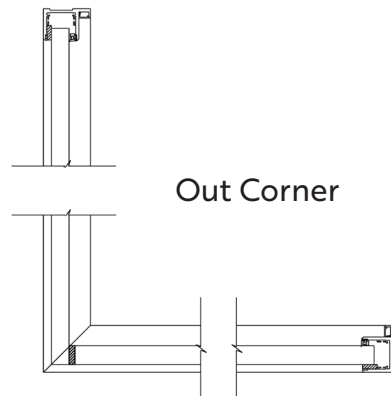

Out Corner

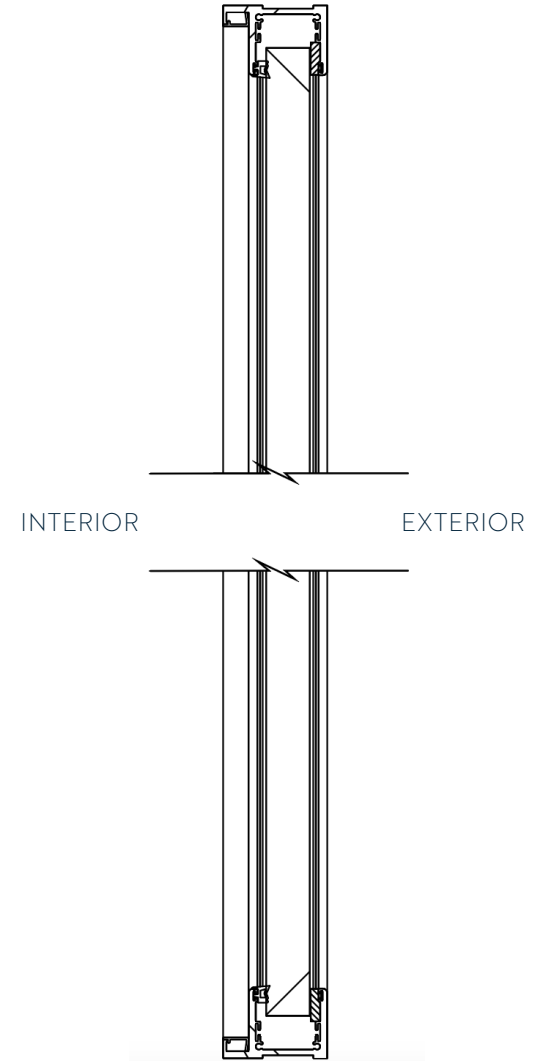

Vertical Cross Section



euro-wall.com



American
CRAFTSMANSHIP

MANUFACTURING & SHOWROOM

2200 Murphy Ct.
North Port, FL 34289
888.989.EURO (3876)

SHOWROOM

1211 Stirling Rd., Unit 102,
Dania Beach, FL 33004
941.979.5316

EURO-WALL UNLOCKS *brehtaking perspectives*
THROUGH THE *largest, strongest* DOOR & WINDOW
SYSTEMS WITH THE MOST DESIGN OPTIONS – ALL
BACKED BY *enjoyable, personal* SUPPORT – FOR A
superior experience FROM OPEN TO CLOSE.



© 2026 Euro-Wall, LLC. Unless Otherwise noted, all proprietary names are trademarks of Euro-Wall. All rights reserved.

