

# VISTA TL™ IMPACT RATED



The Vista TL™ fixed window system is engineered to beautifully complement our innovative door systems. Vista TL™ offers seamless connected glass, providing a sleek, modern appearance. It also boasts expansive height and width dimensions, maximizing the glass-to-frame ratio that enhances natural light and delivers unobstructed views. It's the perfect choice for any project, combining personal support with cutting-edge design.

**FL47174**



## PANEL MINIMUM / MAXIMUM

Min Panel Width:	14"	Min Panel Height:	14"
Max Panel Width:	198"	Max Panel Height:	198"

## OVERVIEW DIAGRAM

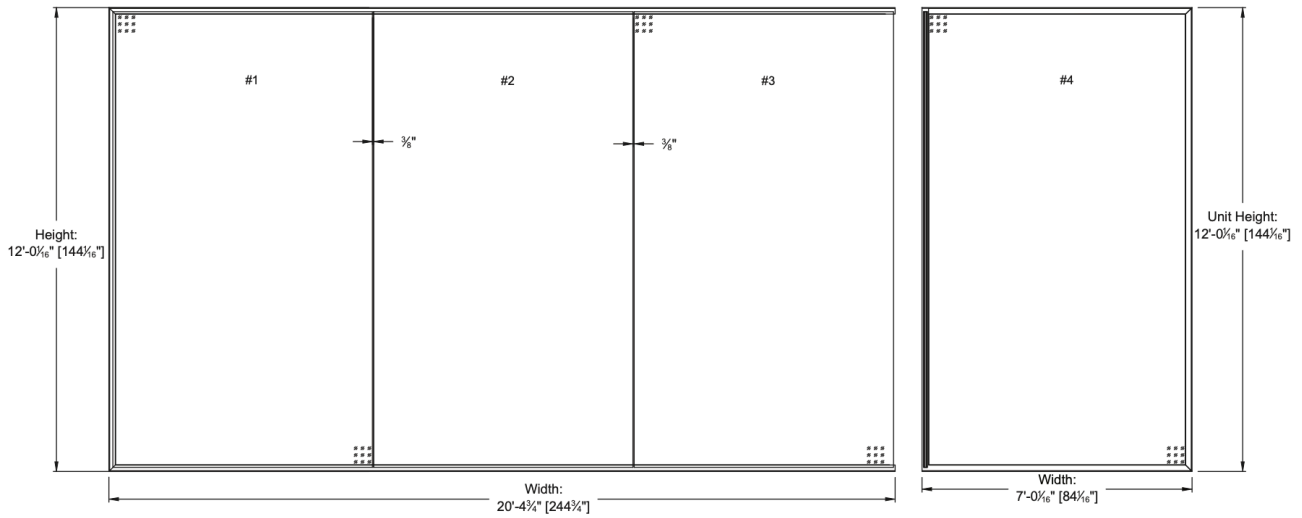

**Exterior Front Elevation**

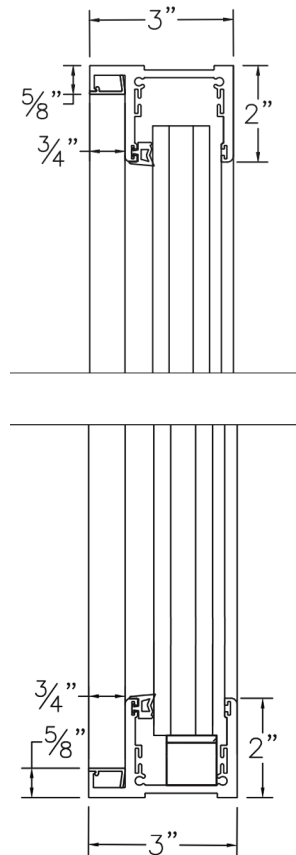

**Vertical Cross Section**

## EXTRUSION PROFILES

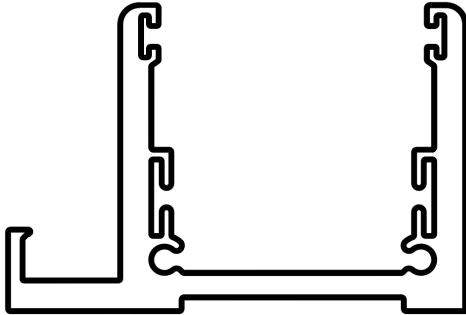

**Frame**  
E0001

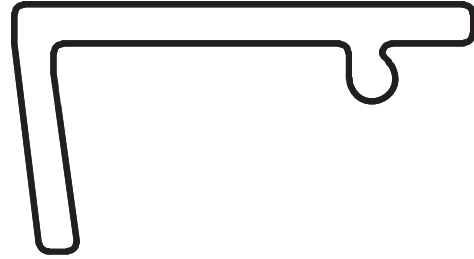

**Screw Cover**  
E0114

## FINISH OPTIONS

### Standard Finishes

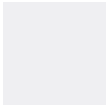

White



Clear  
Anodized



Bronze



Black

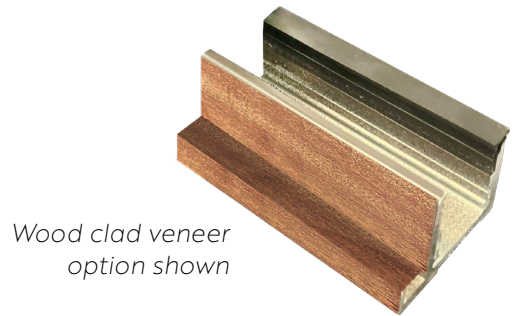

*Wood clad veneer  
option shown*

### Standard Wood Finishes



Mahogany /  
Sapele

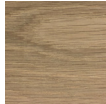

White Oak

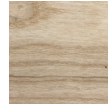

Ash



Birch



Curly Maple



Red Oak



Walnut



Zebrawood

### Exotic Wood Finishes

### Faux Wood Grain Finishes

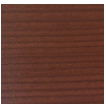

Chesnut  
Cherry

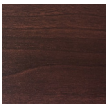

Cinnamon  
Red

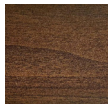

Dark  
Walnut

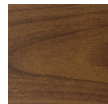

Hazelnut  
Brown



Honey  
Pine

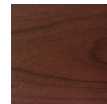

Mahogany  
Red

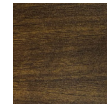

Walnut  
Brown

*NOTE: All Interior wood clad veneer products should be properly finished or sealed within 36 hours of delivery or stored in a climate controlled space until it can be properly finished or sealed.*

## GLAZING DETAILS

1 1/8"

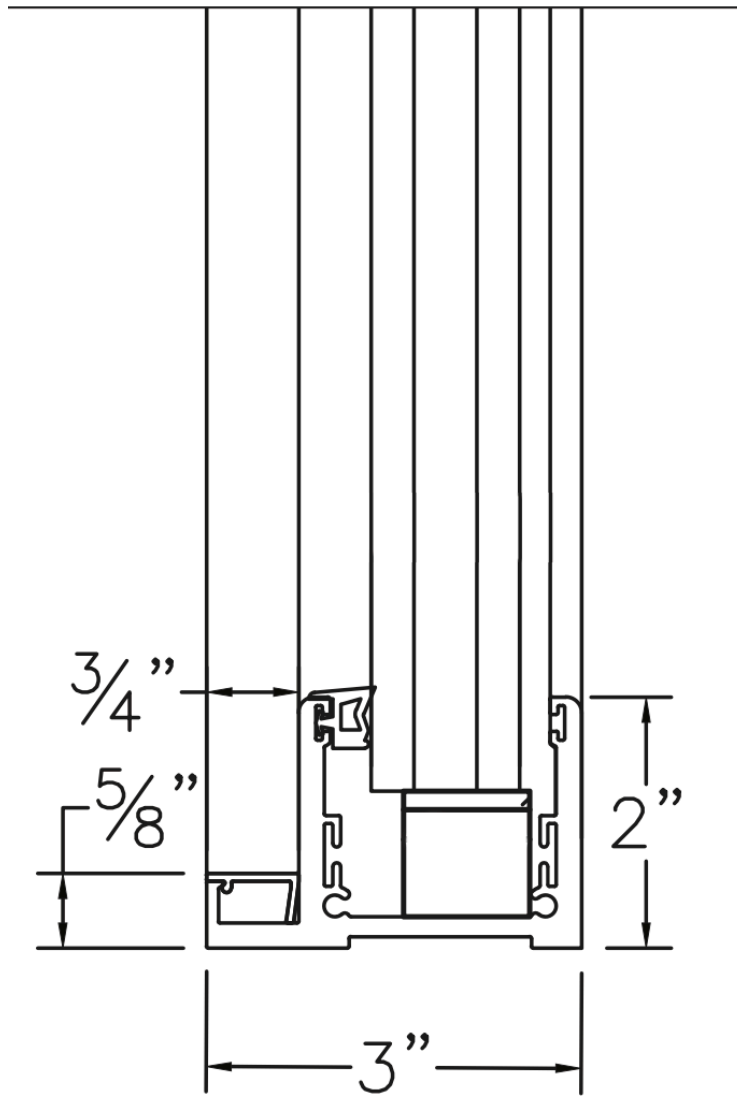

## CONFIGURATIONS

### SINGLE UNIT

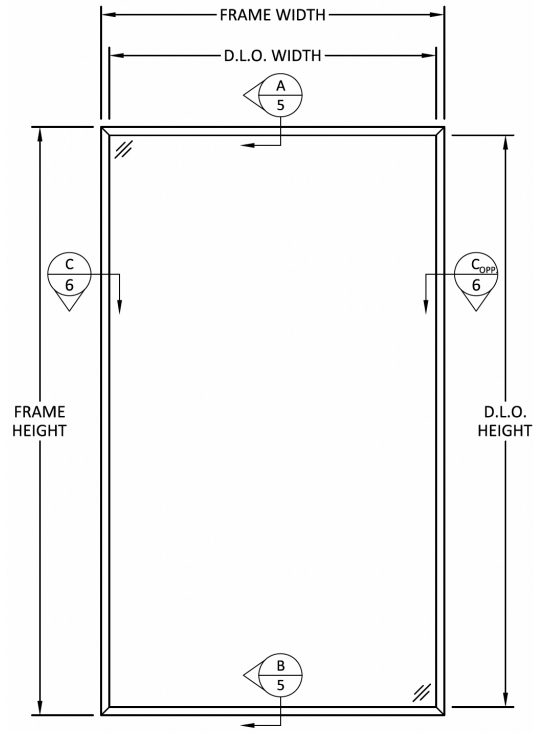

### MULTIPLE UNITS

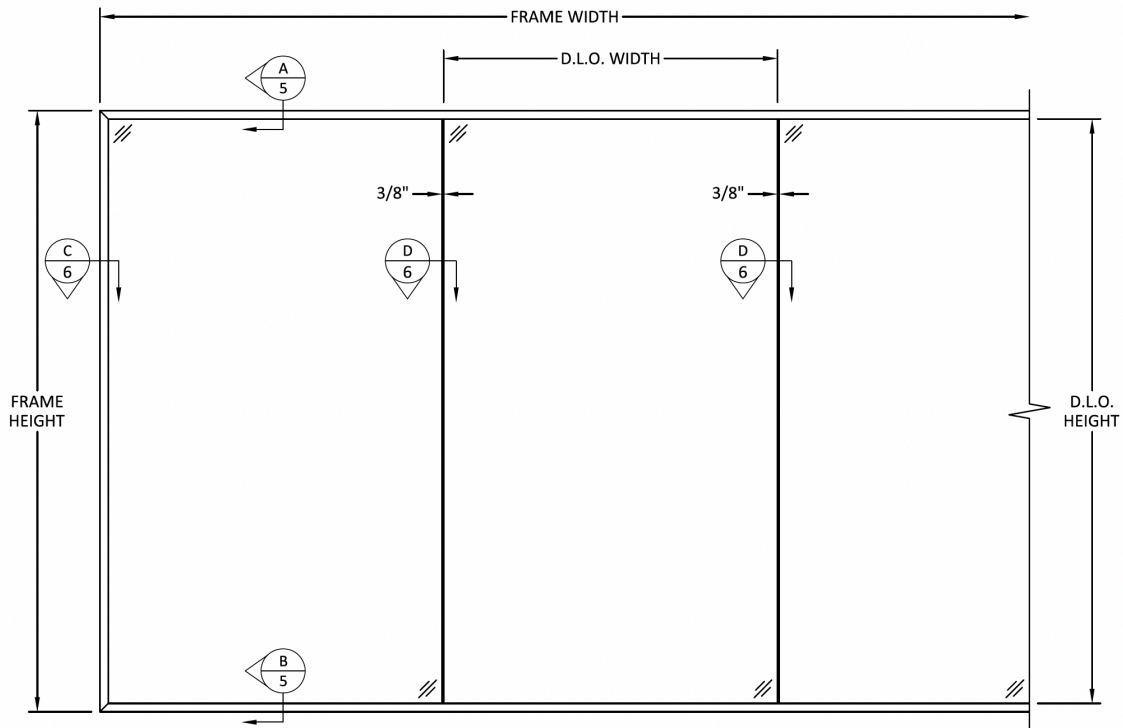

# CONFIGURATIONS

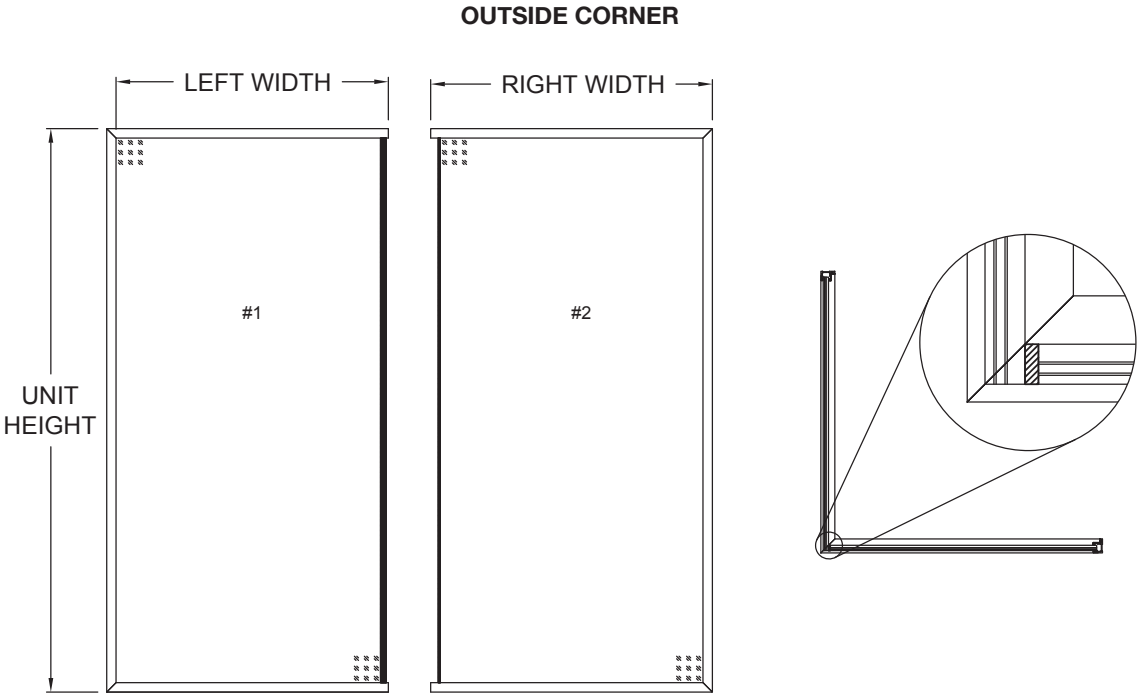

## DESIGN PRESSURE CHARTS

DESIGN PRESSURE CHART (SINGLE UNIT)

HVHZ & WZ3

Frame Width

	60	72	84	96	108	120	132	144	156	168	180	192	198
60	90	90	90	90	90	90	90	90	90	90	90	90	90
72	90	90	90	90	90	90	90	90	90	90			
84	90	90	90	90	90	90	90	90					
96	90	90	90	78.4	78.4	78.4							
108	90	90	90	78.4	69.5								
120	90	90	90	78.4									
132	90	90	90										
144	90	90	90										
156	90	90											
168	90	90											
180	90												
192	90												
198	90												

DESIGN PRESSURE CHART (MULTI-UNIT & CORNERS)

HVHZ & WZ3

DLO Width

	26	38	50	62	68	80	86	98	110	116	128	140	146	164	176	194
60	90	90	90	90	90	90	90	90	90	90	90	90	90	90	90	90
66	90	90	90	90	90	90	90.0	90	90	90	90	90	90	90	90	
72	90	90	90	90	90	90	90.0	90	90	90	90	90	90	90	90	
78	90	90	90	90	90	90	90.0	90	90	90	90	90	90	90	90	
84	90	90	90	90	90	90	90.0	90	90	90	90	90	90	90	90	
90	90	90	90	90	90	90	90.0	83.8	83.8	83.8	83.8					
96	90	90	90	90	90	90	83.8	78.5	78.5	78.5						
102	90	90	90	90	90	90	83.8	73.7	73.7							
108	90	90	90	90	90	90	83.8	73.7								
114	90	90	90	90	90	90	83.8	73.7								
120	90	90	90	90	90	90	83.8									
126	90	90	90	90	90	90	83.8									
132	90	90	90	90	90	90	83.8									
138	90	90	90	90	90	90	90									
144	90	90	90	90	90	90	90									
150	90	90	90	90	89.1											
156	90	90	90	84.6												
165	90	90	81.1													
180	90.0	84.6	65.3													
192	90.0	69.3														
198	90.0	63.0														

## TEST PERFORMANCE RESULTS

- Approved for use in Miami-Dade HVHZ Zone
- Florida Building Code Approved Product Approval FL 46965
- Tested for Thermal Requirements
- Air Infiltration: (ASTM E283/E283M-19)
- Water Infiltration: (ASTM E331-00)
- Wind Load: (TAS 202-94)
- Large Missile Impact: (TAS 201-94) (ASTM E1996-20)
- Cyclic Load: (TAS 203-94) (ASTM E1886-19)
- Product Approval: FL47174



## **EURO-WALL 10 YEAR WARRANTY**

Euro-Wall warrants the products to be free from manufacturing defects for a period of 10 years from the date of purchase.

---

888.989.EURO (3876)

[www.euro-wall.com](http://www.euro-wall.com)

### **MANUFACTURING**

2200 Murphy Court  
North Port, Florida 34289  
888.989.3876 • 941.979.5316



### **SHOWROOM**

1211 Stirling Road, Unit 102,  
Dania Beach, Florida 33004  
954.610.2572

Proud Member of the American Architectural Manufacturers Association.

