



Vista DSTM



IMPACT & NON-IMPACT RATED
Fixed Window System



#FL46965
V2. 032026

Features & Benefits

Largest Panel Sizes

Enjoy the view through some of the industry's largest panels (up to 14' tall and up to 9' wide available).

Design Flexibility

Make it yours with custom colors, interior wood clad, custom muntin, simulated divided lites, mid-rails and other aesthetic offerings.

Connected Panels

Connect multiple panels together for an impressive wall of glass with just a narrow 1 ¼" meeting rail for unobstructed views.

Long Lasting Finish

Lakefront, oceanfront and everywhere in between, enjoy your window for years to come with the high-quality finish options.

Configurations

Choose from single units or multiple units, as well as different glass options to fit your unique needs.



A New Point of View



Introducing the all-new Vista DS™ fixed window system, engineered to beautifully complement our innovative door systems.

Designed from the ground up based on feedback from our popular Storefront™ product, Vista DS™ offers some of the thinnest profiles for either fixed or operable fenestration products (just 1 ¼") – providing a sleek, modern appearance. It also boasts expansive height and width dimensions, maximizing the glass-to-frame ratio that enhances natural light and delivers unobstructed views.

It's the perfect choice for any project, combining personal support with cutting-edge design.



DESIGN PRESSURE CHART (SINGLE UNIT)

HVHZ, WZ3, & Non-Impact

Panel Height	Panel Width												
	36	42	48	54	60	66	72	78	84	90	96	102	108
78	70	70	70	70	70	63.6	58.3	53.8	53.8	53.8	53.8	53.8	53.8
84	70	70	70	70	70	63.6	58.3	53.8	50	50	50	50	
90	70	70	70	70	70	63.6	58.3	53.8	50	46.7	46.7		
96	70	70	70	70	70	63.6	58.3	53.8	50	46.7			
102	70	70	70	70	70	63.6	58.3	53.8	50				
108	70	70	70	70	70	63.6	58.3	53.8					
114	70	70	70	70	70	63.6	58.3						
120	70	70	70	70	70	63.6	58.3						
126	70	70	70	70	70	63.6							
132	70	70	70	70	70								
138	70	70	70	70	70								
144	70	70	70	70	70								
150	70	70	70	70									
156	70	70	70	70									
162	70	70	70										
168	70	70	70										

DESIGN PRESSURE CHART (MULTIPLE UNITS)

HVHZ

Panel Height	Panel Width												
	36	42	48	54	60	66	72	78	84	90	96	102	108
78	70	70	70	70	70	63.6	58.3	53.8	53.8	53.8	53.8	53.8	53.8
84	70	70	70	70	70	63.6	58.3	53.8	50	50	50	50	
90	70	70	70	70	70	63.6	58.3	53.8	50	46.7	46.7		
96	70	70	70	70	70	63.6	58.3	53.8	50	46.7			
102	70	70	70	70	70	63.6	58.3	53.8	50				
108	70	70	70	70	70	63.6	58.3	53.8					
114	70	70	70	70	70	63.6	58.3						
120	70	70	70	70	70	63.6	58.3						
126	70	70	70	70	70	63.6							
132	70	70	70	70	70								
138	70	70	70	70	70								
144	70	70	70	70	70								

WZ3, & Non-Impact

Panel Height	Panel Width												
	36	42	48	54	60	66	72	78	84	90	96	102	108
78	70	70	70	70	70	63.6	58.3	53.8	53.8	53.8	53.8	53.8	53.8
84	70	70	70	70	70	63.6	58.3	53.8	50	50	50	50	
90	70	70	70	70	70	63.6	58.3	53.8	50	46.7	46.7		
96	70	70	70	70	70	63.6	58.3	53.8	50	46.7			
102	70	70	70	70	70	63.6	58.3	53.8	50				
108	70	70	70	70	70	63.6	58.3	53.8					
114	70	70	70	70	70	63.6	58.3						
120	70	70	70	70	70	63.6	58.3						
126	70	70	70	70	70	63.6							
132	70	70	70	70	70								
138	70	70	70	70	70								
144	70	70	70	70	70								
150	70	70	70	70	70								
156	70	70	66.6	67.6	59.8								
162	70	67.2	59.3										
168	69.7	60.2	53.1										

Test Performance

- Air Infiltration: ASTM E283-19
- Water Infiltration: ASTM E331-00(23)
- Wind Load: TAS 202-94
- Large Missile Impact: TAS 201-94
- Cyclic Load: TAS 203-94



#FL46965

System Thresholds

MAXIMUM / MINIMUM SPECIFICATIONS

SINGLE UNIT

	IMPACT RATED	NON-IMPACT RATED
MAX. PANEL HEIGHT	168"	168"
MAX. PANEL WIDTH	108"	108"
MIN. PANEL HEIGHT	18"	18"
MIN. PANEL WIDTH	18"	18"

Note: The height and width are interchangeable to accommodate vertical or horizontal arrangements.

MULTIPLE UNITS

	HVHZ	WZ3 & NON-IMPACT
MAX. PANEL HEIGHT	144"	168"
MAX. PANEL WIDTH	108"	108"
MIN. PANEL HEIGHT	18"	18"
MIN. PANEL WIDTH	18"	18"

Note: For installations in Florida, please see the Florida Product Approval (FL46965) for usage and limitations.



10-Year Limited Warranty

Euro-Wall warrants the products to be free from manufacturing defects for a period of 10 years.



Note: 1" IG shown.

Single Lite CAD details

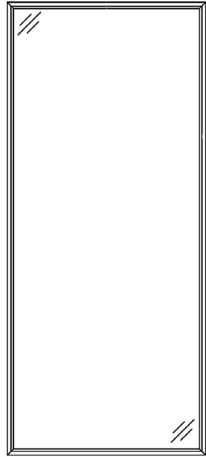

Exterior Front Elevation

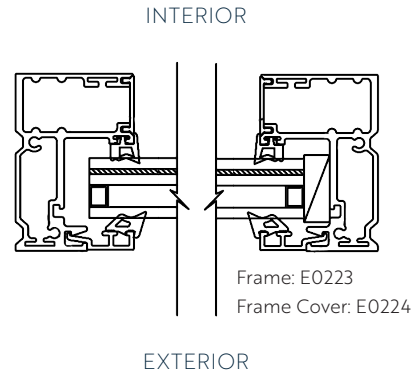

Top Down Cross Section

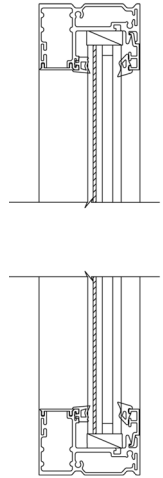

Vertical Cross Section

Divided Lite CAD details

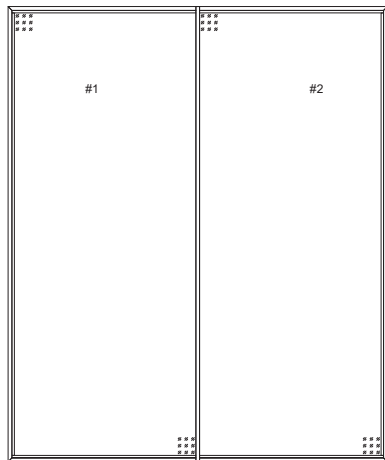

Exterior Front Elevation

Exterior Assembly

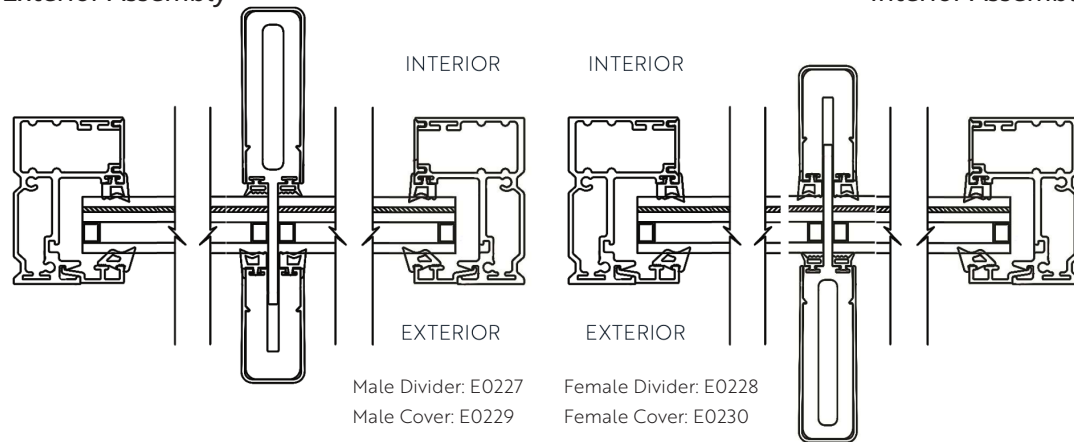

Top Down Cross Section

Interior Assembly

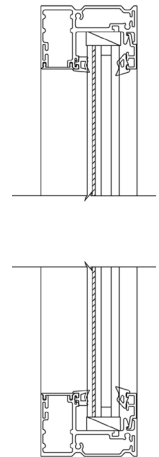

Vertical Cross Section

Glazing Details

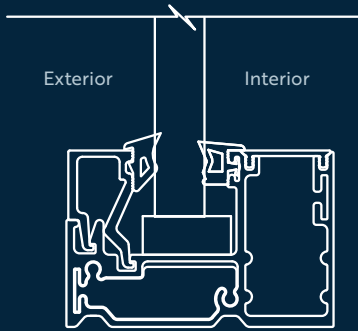

9/16" LAMINATE

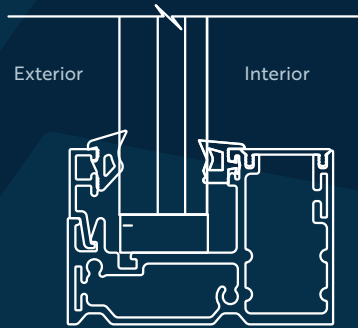

1" IG

OVERALL GLASS THICKNESS

¼" | ½" | 9/16" | 1"

We can handle most any type of glass if it meets the required thickness. *Let's talk.*

Finish Options

STANDARD FRAME & DOOR PANEL FINISHES

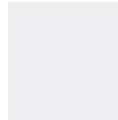

White
UC40577



Bronze
UC91252



Black
UC40577



Clear
Anodized

Note: Standard finish is Kynar® AAMA 2605. Additional custom powder coat or Kynar® finishes available upon request.

STANDARD INTERIOR WOOD CLAD FINISHES

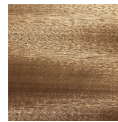

Mahogany /
Sapele



White Oak

Wood clad veneer
option shown



EXOTIC INTERIOR WOOD CLAD FINISHES



Ash



Birch



Curly Maple



Red Oak

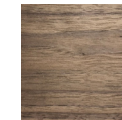

Walnut

Note: Additional exotic wood finish options available upon request.

FAUX WOODGRAIN FINISHES



Aspen

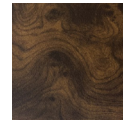

Burlwood

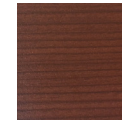

Chesnut Cherry

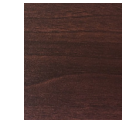

Cinnamon Red

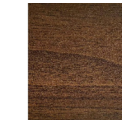

Dark Walnut



English Oak

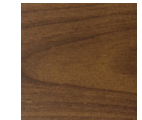

Hazelnut Brown

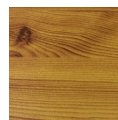

Honey Pine

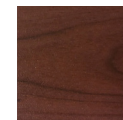

Mahogany Red



Natura

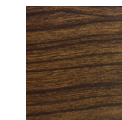

Teak

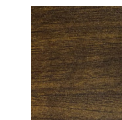

Walnut Brown

Note: A faux woodgrain finish is a powder coat with die sublimation to an AAMA 2604 finish qualification. Additional faux woodgrain options available upon request. The colors shown are an approximation of actual colors and finishes, actual finishes may vary slightly.



euro-wall.com



American
CRAFTSMANSHIP

MANUFACTURING & SHOWROOM

2200 Murphy Ct.
North Port, FL 34289
888.989.EURO (3876)

SHOWROOM

1211 Stirling Rd., Unit 102,
Dania Beach, FL 33004
941.979.5316

EURO-WALL UNLOCKS *brehtaking perspectives*
THROUGH THE *largest, strongest* DOOR SYSTEMS
WITH THE MOST DESIGN OPTIONS – ALL BACKED
BY *enjoyable, personal* SUPPORT – FOR A *superior*
experience FROM OPEN TO CLOSE.



© 2026 Euro-Wall, LLC. Unless Otherwise noted, all proprietary names are trademarks of Euro-Wall. All rights reserved.

